

# Installation and operating instructions

## TOUCH1200<sup>®</sup>



Version: V9.20191001



30322537-02-EN

Read and follow these instructions. Keep these instructions in a safe place for later reference. Please note that there might be a more recent version of these instructions on the homepage.

## Company details

<b>Document</b>	Installation and operating instructions Product: TOUCH1200® Document number: 30322537-02-EN As of software version: 02.20.17 Original instructions Original language: German
<b>Copyright ©</b>	Müller-Elektronik GmbH Franz-Kleine-Straße 18 33154 Salzkotten Germany Phone: ++49 (0) 5258 / 9834 - 0 Fax: ++49 (0) 5258 / 9834 - 90 Email: <a href="mailto:info@mueller-elektronik.de">info@mueller-elektronik.de</a> Homepage: <a href="http://www.mueller-elektronik.de">http://www.mueller-elektronik.de</a>

## Table of contents

<b>1</b>	<b>For your safety</b>	<b>7</b>
1.1	Basic safety instructions	7
1.2	Intended use	8
1.3	Layout and meaning of warnings	8
1.4	Disposal	9
1.5	Instructions on retrofitting	9
1.6	EU declaration of conformity	9
<b>2</b>	<b>About these Operating Instructions</b>	<b>11</b>
2.1	Target group of these Operating Instructions	11
2.2	Layout of operating instructions	11
2.3	Layout of references	11
2.4	Directional information in these instructions	11
<b>3</b>	<b>Product description</b>	<b>12</b>
3.1	Scope of delivery	12
3.2	Terminal buttons	12
3.3	Terminal ports	13
3.4	Applications on the terminal	13
3.5	Information on the rating plate	15
<b>4</b>	<b>Mounting and installation</b>	<b>16</b>
4.1	Mounting the terminal in the vehicle cab	16
4.1.1	Mounting the standard bracket	16
4.1.2	Mounting the optional adapter	17
4.2	Connecting the terminal to the ISOBUS	17
4.3	Inserting micro-SD card	18
4.4	Inserting micro-SD card	19
4.5	Using two terminals	20
<b>5</b>	<b>Basic control principles</b>	<b>22</b>
5.1	Switching on the terminal	22
5.2	Initial start-up	22
5.2.1	Using the terminal for parallel driving	22
5.2.2	Operating ISOBUS implement	23
5.2.3	Terminal for automatic section control	23
5.2.4	Terminal for task management	24
5.3	Switching off the terminal	25
5.4	Terminal screen layout	25
5.5	Opening applications	26
5.6	Moving an application	27

5.7	Moving open applications	28
5.8	Saving and loading window arrangements	29
5.9	Hiding an application	29
5.10	Using the keyboard	29
5.11	Using a memory device	30
5.11.1	Using SD card	30
5.11.2	Folders on the USB memory device	30
5.11.3	Displaying the content of the memory device on the terminal	31
<b>6</b>	<b>Connecting and configuring external devices</b>	<b>32</b>
6.1	GPS receiver	32
6.1.1	Connecting the GPS receiver to the terminal	32
6.1.2	Changing the driver for the GPS receiver	32
6.1.3	Configuring the GPS receiver	34
	Parameters for the GPS receiver	34
	RTK or L band licence for SMART-6L	37
	GSM modem for SMART-6L	37
	Configuring the GPS receiver for the steering system	38
6.1.4	Recording GPS position	39
6.1.5	Configuring the “GPS TILT-Module” tilt module	40
6.2	Configuring the joystick button allocations	40
6.3	Connecting sensors to the terminal	41
6.4	Camera	42
6.4.1	Connecting the camera to the terminal	42
	Connecting the camera HQ2	42
	Connecting the camera NQ	43
6.4.2	Activating a camera	43
6.4.3	Operating the camera	44
6.5	External lightbar	44
6.5.1	Connecting the external lightbar to the terminal	44
6.5.2	Activating an external lightbar	45
6.6	Connecting the on-board integrated display/controller to the terminal	45
6.7	ISO Printer	46
6.7.1	Connecting the ISO printer to the terminal	46
6.7.2	Activating ISO Printer	47
6.8	farmpilot	47
6.8.1	Activating farmpilot	47
6.8.2	Configuring the connection with farmpilot	47
6.9	Configuring the Bluetooth connection in the Connection Center	48
6.10	Crop protection sensors	49
<b>7</b>	<b>Configuring the terminal in the Service application</b>	<b>50</b>
7.1	Changing the language	50
7.2	Changing the layout	50
7.3	Basic terminal settings	52
7.4	Activating and deactivating applications	53

7.5	Unlocking licenses for full versions	54
7.6	Creating screenshots	55
7.7	Deleting pools	55
7.8	Using the Open Data Interface	56
7.8.1	Activating ME ODI	56
7.8.2	Opening ME ODI	56
<b>8</b>	<b>Tractor-ECU application</b>	<b>58</b>
8.1	Work screen	58
8.2	Managing the tractor profiles	58
8.3	Parameter	60
8.3.1	Calibrating the speed sensor	62
8.3.2	Calibrating an analog work position sensor	63
8.3.3	Tractor geometry	63
	Configuring the tractor connector types	64
	Configuring the tractor geometry	65
8.4	Results	66
8.4.1	Trip counter	66
8.4.2	Task-related counter	66
<b>9</b>	<b>Virtual ECU application</b>	<b>68</b>
9.1	Managing virtual job computers	68
9.2	Parameter	69
9.3	Work screen	72
<b>10</b>	<b>Task management (ISOBUS-TC)</b>	<b>73</b>
10.1	Configuring ISOBUS-TC	73
10.1.1	The “farmipilot” parameter	73
10.1.2	“Operating Mode” parameter	73
10.1.3	“TC number” parameter	74
10.1.4	“Prefer internal Tractor-ECU?” parameter	74
10.1.5	“Save finished tasks as a file?” parameter	74
10.1.6	“Validation of the device description” parameter	74
10.1.7	“Simplified target rate assignment?” parameter	75
10.2	Configuring the list of connections	75
10.3	Using fields and shp data	76
10.3.1	What is field data for?	77
10.3.2	Creating fields	77
10.3.3	Activating and deactivating fields	78
10.3.4	Importing field data (*.shp)	79
10.3.5	Exporting field data	79
10.3.6	Data on the memory device	80
10.3.7	Transferring field data to a different terminal	80
10.4	Using prescription maps	80
10.4.1	Importing shape prescription maps	81
10.4.2	Selecting shape prescription maps	82
10.4.3	Editing shape prescription maps	82

10.4.4	ISO-XML prescription maps	83
10.5	MULTI-Control	83
<b>11</b>	<b>FILE-Server application</b>	<b>85</b>
<b>12</b>	<b>Technical specifications</b>	<b>86</b>
12.1	Technical specifications of the terminal	86
12.2	Pin-out diagrams	87
12.2.1	Port A (CAN bus)	87
12.2.2	Port B	87
12.2.3	Port C	88
12.2.4	Ports D and E (camera)	89
12.2.5	ETH (Ethernet) port	90
12.3	Licence conditions	90
<b>13</b>	<b>Troubleshooting</b>	<b>91</b>

# 1 For your safety

## 1.1

### Basic safety instructions



Please read the following safety instructions carefully before using the product for the first time.

- Do not operate the terminal while driving in road traffic. Come to a standstill in order to use the unit.
- Before maintenance or repair to the tractor, always disconnect the connection between the tractor and the terminal.
- Before charging the tractor battery, always disconnect the connection between the tractor and the terminal.
- Before welding on the tractor or implement, always disconnect the power supply to the terminal.
- Do not make any unauthorized modifications to the product. Unauthorized modifications or use may impair safety and reduce the service life or operability of the unit. Modifications are considered unauthorized if they are not described in the product documentation.
- Follow all recognised safety, industrial and medical rules as well as all road traffic laws.
- The product does not include any user-serviceable parts. Do not open the casing. If the casing is opened, its imperviousness can be changed.
- Read the operating instructions to the agricultural device which you want to control by using the product.



#### Terminals with GSM modem

If the terminal is fitted with a built-in GSM modem, this will emit radio waves when it is switched on. These can interfere with other equipment or be harmful to human health.

You should therefore follow the instructions below when the terminal is fitted with a GSM modem:

- If you wear a medical device, ask your doctor or the device manufacturer how to proceed in order to prevent risks. Medical devices such as pacemakers or hearing aids may be sensitive to the radio signal of the built-in GSM modem.
- If you wear a pacemaker, keep the terminal away from the pacemaker.
- Switch off the terminal as soon as you are close to a gas station, chemical plant, biogas plant or any other location where combustible gases or fumes may be present. These gases can be ignited by a spark and explode.
- Always maintain a distance of at least 20 cm (8 inches) between the GSM antenna and your body.
- Never switch the terminal on in an aircraft. Make sure that it is not accidentally switched on during flight.
- Never connect the terminal by means of a power supply to the mains network. Only use the vehicle battery.



#### Using a camera

The camera serves **solely** for observing the implement functions in non-safety-related working areas of the agricultural implement.

In certain situations, the camera image may appear on the screen with a delay. The delay depends on the respective use of the terminal and can also be affected by external factors and devices.

For this reason, please note the following information:

- Do not use the camera to assist with steering the vehicle: not in road traffic, and not on private properties.

- Do not use the camera to watch the road traffic or when driving into intersections.
- Do not use the camera as a rear view camera.
- Do not use the camera as a visual aid for controlling the implement, especially when a delayed reaction can lead to risks.
- Using a camera does not exempt you from your due diligence obligation to pay attention to safety when operating the implement.

## 1.2

### Intended use

The terminal is used to operate implements equipped with ISOBUS job computers.

Intended use also includes compliance with the conditions for operation and repairs prescribed by the manufacturer.



The manufacturer cannot be held liable for any personal injury or property damage resulting from such non-compliance. All risk arising from improper use lies with the user.



All applicable accident prevention regulations and all other generally recognized safety, industrial, and medical standards as well as all road traffic laws must be observed. Any unauthorized modifications made to the equipment will void the manufacturer's warranty.

## 1.3

### Layout and meaning of warnings

All safety instructions found in these Operating Instructions are composed in accordance with the following pattern:

	 <b>WARNING</b>
	<p>This signal word identifies medium-risk hazards, which could potentially cause death or serious physical injury, if not avoided.</p>

	 <b>CAUTION</b>
	<p>This signal word identifies hazards that could potentially cause minor or moderate physical injury or damage to property, if not avoided.</p>

### NOTICE

This signal word identifies hazards that could potentially cause damage to property, if not avoided.

There are some actions that need to be performed in several steps. If there is a risk involved in carrying out any of these steps, a safety warning appears in the instructions themselves.

Safety instructions always directly precede the step involving risk and can be identified by their bold font type and a signal word.

#### Example

1. **NOTICE!** This is a notice. It warns that there is a risk involved in the next step.
2. Step involving risk.



## 1.4 Disposal



When it has reached the end of its service life, please dispose of this product as electronic scrap in accordance with all applicable waste management laws.

## 1.5 Instructions on retrofitting

### Instructions on how to retrofit electrical and electronic farm equipment and/or components

Agricultural equipment used today features electronic components and parts whose function can be affected by other farm equipment which emits electromagnetic waves. Such effects could lead to personnel being put in danger, if the following safety instructions are not adhered to.

#### Selecting components

When selecting components, make sure first of all that the retrofitted electrical and electronic components comply with the current version of the EMC Directive 2004/108/EC and carry the CE marking.

#### User responsibility

When retrofitting a machine with electrical and electronic farm equipment and/or components connected to the vehicle's electrical system, it is your own responsibility to check whether the installation causes interference with the vehicle's electronic system or other components. This applies, in particular, to the electronic control of:

- electronic hitch control (EHR),
- Front lifting gear,
- PTO shafts,
- Motor,
- Gear.

#### Additional requirements

The following requirements must be met in order to retrofit mobile communication systems (e.g. radio, phone):

- Only approved devices complying to national regulations (e.g. BZT approval in Germany) are to be installed;
- The equipment must be installed as a fixed installation.
- The use of portable or mobile devices inside the vehicle is permissible only via a connection to the permanently installed outside antenna;
- The transmitting part must be spatially separated from the vehicle's electronic system.
- When attaching the antenna, pay attention to proper installation, including a sound ground connection between the antenna and the vehicle's ground wire.

For information on wiring and installation as well as the maximum allowable current consumption, please also refer to the installation guide provided by the machine manufacturer.

## 1.6 EU declaration of conformity

Herewith we declare that the design and construction of this product and its identical variants, as well as the form brought onto the market by us, is in accordance with the relevant safety and health requirements of the EU Directive of Electromagnetic Compatibility 2014/30/EU. If alterations are made to the product without prior consultations with us, this declaration becomes invalid.

**TOUCH1200®**

Harmonised standards applied:

EN ISO 14982:2009

(EMC Directive 2014/30/EU)

## 2 About these Operating Instructions

### 2.1 Target group of these Operating Instructions

These Operating Instructions are intended for personnel entrusted with installing and operating the terminal.

### 2.2 Layout of operating instructions

The operating instructions explain step by step how you can perform certain operations with the product.

We use the following symbols throughout these Operating Instructions to identify different operating instructions:

Type of depiction	Meaning
1. 2.	Actions that must be performed in succession.
⇒	Result of the action. This will happen when you perform an action.
⇨	Result of an operating instruction. This will happen when you have completed all steps.
☑	Requirements. In the event that any requirements have been specified, these must be met before an action can be performed.

### 2.3 Layout of references

If any references are given in these Operating Instructions, they appear as:

Example of a reference: [→ 11]

References can be identified by their square brackets and an arrow. The number following the arrow shows you on what page the section starts where you can find further information.

### 2.4 Directional information in these instructions

All directional information in these instructions, such as "left", "right", "forward", "back", is relative to the movement direction of the vehicle.

## 3 Product description

### 3.1 Scope of delivery

The following items are included in delivery:

- TOUCH1200 terminal
- VESA holder and screws
- Bracket for mounting the terminal
- USB memory device
- Installation and Operating Instructions
- Operating instructions for the ISOBUS-TC application - as a separate document.

### 3.2 Terminal buttons







You will find a number of buttons on the housing of the terminal that are used to operate the terminal.



Terminal buttons

①	Buttons on the front site	②	Buttons on the rear site The buttons on the rear side do not have any function.
---	---------------------------	---	--

#### Function of the buttons

	Switches the terminal on and off.
	Creates screenshots. [→ 55]
	Saves the window layout [→ 29].
	No function
	No function
	No function
	No function

### 3.3

### Terminal ports



Overview of the ports

①	Optional GSM port for: - GSM antenna	ETH	ETH port M12 port for: - Ethernet
A	Port A CAN bus port for: - ISOBUS basic vehicle harness [→ 17]	D	Port D Port for: - Analog camera [→ 42]
B	Port B See section: Pin assignment connector B	E	Port E is not used.
C	Port C Serial port for: - GPS receiver [→ 32] - GPS TILT-Module - Lightbar [→ 44]	②	USB port for: - USB memory device [→ 30]

### 3.4

### Applications on the terminal

The terminal is delivered with a range of installed application (apps). Most of these can be used immediately. Even the non-activated applications can generally be tested for 50 hours. If a specific application works well for you, a license can be ordered from Müller-Elektronik to activate the full version of the application.

#### Full versions

The full versions of the following applications are installed on the terminal:

- **ISOBUS interface (ISOBUS-UT)**  
The terminal enables you to operate ISOBUS job computers which are ISO 11783 compliant. The user interfaces for operating a job computer are shown on the terminal screen if this is connected to the ISOBUS connector of the vehicle.  
The ISOBUS interface has no icon of its own. The icon for the connected job computer will always be displayed in the selection menu.



- **- Service application.**  
The Service application allows you to:
  - Configure the terminal.
  - Enable and disable other applications.
  - Enter license activation codes.
  - Enable drivers for connected devices.
  - Configuration of the GPS settings



- - ISOBUS-TC application (ISOBUS task controller)

The ISOBUS-TC application serves as an interface between the terminal applications (SECTION-Control, TECU, VECU) and ISOBUS devices (job computers, crop protection sensors). Moreover, the app enables data transfer between the terminal and electronic Farm Management Information Systems.

The scope of functions depends on the activated licenses and the configuration.

More about this in section: Task management (ISOBUS-TC) [→ 73]



- - Tractor-ECU application

The Tractor-ECU application is used to record all settings around the tractor.

Here, you can e.g.:

- Enter the position of the GPS receiver.
- Set the GPS receiver as the speed signal source.
- Select which sensor signals are received by the terminal.
- View the speed and PTO shaft rotational speed on the screen.

More about this in section: Tractor-ECU application [→ 58]



- - Virtual ECU application

The Virtual ECU application is a central hub where virtual job computers can be created for machines and devices that do not communicate through ISOBUS.

The Virtual ECU enables the use of apps such as TRACK-Leader, ISOBUS-TC and SECTION-Control with non-ISO machines.

More about this in section: Virtual ECU application [→ 68]



- FILE-Server application

This application is used to define a storage location on the terminal. This storage location can be used by ISOBUS job computers that support the FILE-Server functionality. The options for use depend on the ISOBUS job computer.



- - Camera

The Camera application displays on the screen the image from the camera which is connected to the terminal.

## Test versions

You can use the test versions of the following applications:



- - TRACK-Leader application.

The TRACK-Leader application allows you to work the field on exact parallel tracks.

The app contains several modules for which a license can also be activated:

- SECTION-Control: Automatic section control in order to minimize overlaps.
  - TRACK-Leader AUTO: Automatic vehicle steering on the field.
  - TRACK-Leader AUTO CLAAS: Automatic vehicle steering on the field for CLAAS tractors.
  - TRACK-Leader TOP: Automatic vehicle steering on the field.
  - TRAMLIN-Management: Tramlin control using the current GPS position.
- ASD protocol – The license enables communication between the terminal and a serially connected on-board integrated display/controller. The terminal knows the position of the machine on the field (GPS) and can transmit the target application rate of a product (from the prescription



map) or the section status to the on-board integrated display/controller. In this way, you can use the SECTION-Control app for section control, among other things.

More about this in section: Connecting the on-board integrated display/controller to the terminal [ → 45]

- MULTI-Control – This license extends the functionality of ISOBUS-TC. It enables the assignment of prescription maps to individual metering units on a machine.
- ME ODI – This license activates the ME ODI application. It is used to connect the terminal with the Internet via Ethernet or Bluetooth.

### Optional software

Optionally you can activate the following software:

-  - FIELD-Nav application  
FIELD-Nav – Road navigation for agricultural purposes. The map material can be edited with the corresponding PC software FIELD-Nav Desktop. All field tracks, small bridges and other restrictions can then be integrated in the map material and be considered when mapping the route.  
You will find the operating instructions on the Müller-Elektronik website.
-  - Agricon plugin  
Enables coupling with crop protection sensors (Yara-N, P3US, P3ALS etc.) manufactured by Agricon.

## 3.5

### Information on the rating plate

You will find a nameplate sticker on the back of the terminal. On this sticker, you can find all the information you need to definitively identify the product.

Have these details ready when you contact Customer Services.

#### Abbreviations on the rating plate

Abbreviation	Meaning
SW:	Software version You can see the installed software version on the Start Screen of the Service application:
HW:	Hardware version
DC:	Operating voltage The terminal may only be connected to voltages within this range.
K.-Nr.:	Customer number If the terminal was manufactured for an agricultural machinery manufacturer, the agricultural machinery manufacturer's item number will be shown here.
SN:	Serial number

## 4 Mounting and installation

### 4.1 Mounting the terminal in the vehicle cab

You need a bracket to mount the terminal in the vehicle cab. The following brackets are available.

Item number	Type	Scope of delivery?	Properties
31322507	Standard bracket	Yes	
31322508	Optional adapter	No	<ul style="list-style-type: none"> <li>▪ Is mounted on bracket 31322507.</li> <li>▪ Suitable for vehicles without a B column.</li> <li>▪ Is mounted around a pipe.</li> </ul>

#### 4.1.1 Mounting the standard bracket

##### Procedure

You have the bracket assembly kit within reach.

1. Assemble the bracket together.

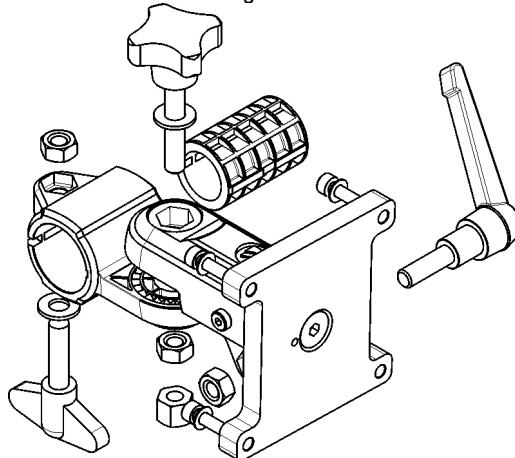

2. Secure the bracket with the four screws on the back side of the terminal.
3. Put the bracket into the desired position. For example:

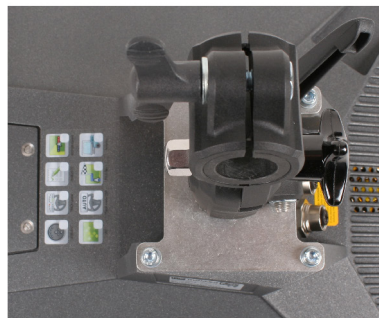



- Secure the terminal in the vehicle cab. You can, for example, use the ME mounting bracket for this purpose. It is included in the scope of delivery of the ISOBUS basic vehicle harness.



- Check that your terminal is firmly mounted.

#### 4.1.2 Mounting the optional adapter

If you want to mount your terminal in a vehicle that does not have a B column, you can install an adapter onto bracket 31322507. This adapter can be mounted around a pipe.

- Adapter for round pipe systems, for pipes with a diameter of 20, 25 or 30 mm, item number: 31322508

##### Procedure

- Assemble the adapter together.

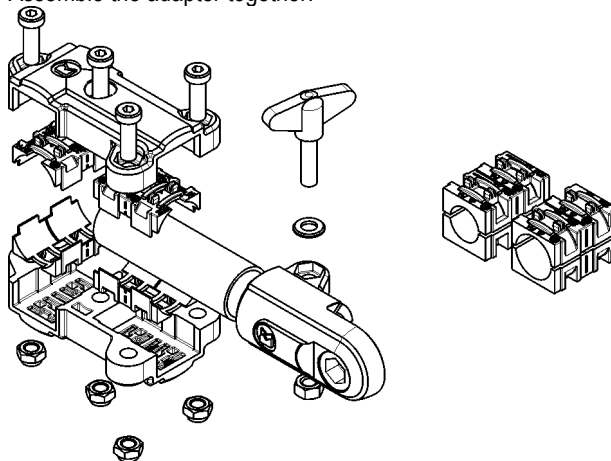

- Connect the adapter with the bracket.

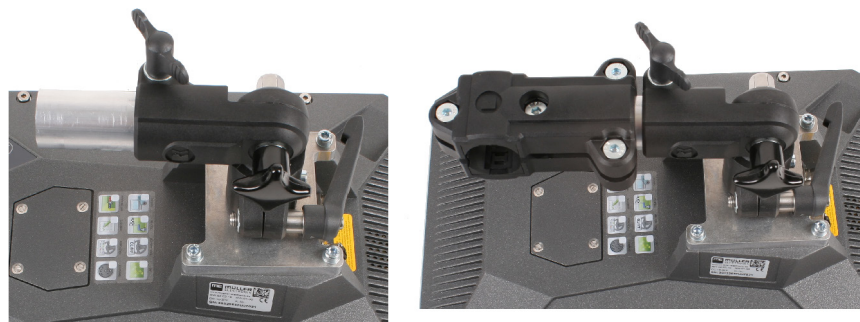

- Put the bracket and the adapter in the desired position.
- Check that everything is firmly mounted.

## 4.2 Connecting the terminal to the ISOBUS

Connection to the ISOBUS serves to:

- supply the terminal with power,
- enable communication with other ISOBUS components.

You will need a different connection cable for this, depending on the model of your tractor.

- In tractors that have been retroactively upgraded with an ISOBUS basic vehicle harness manufactured by Müller-Elektronik, use connector cable A from the ISOBUS basic vehicle harness.
- In tractors that are equipped as standard with ISOBUS and that have an ISOBUS in-cab connector, you will need the following connector cable:



Connector cable D-Sub <-> CPC Item no. 30322541

When there is more than one terminal in the tractor cab, you may need to change certain settings in order to enable two-way communication. Find out more: Using two terminals [→ 20]

**Procedure**

1. Connect the 9-pin connector A of the basic vehicle harness to the CAN port of the terminal.
2. Tighten the safety screws on the connector.

### 4.3 Inserting micro-SD card

The micro-SD card serves as internal storage for the terminal.

**Procedure**

Insert an SD card as follows:

1. Switch off the terminal and disconnect all cable connections.



2. - Unscrew the cover on the rear of the terminal.

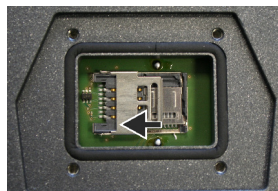

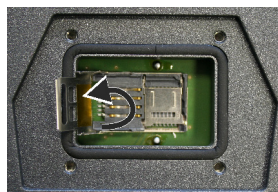

3. - Release the bracket for the SIM card by gently sliding it in the direction of the arrow.

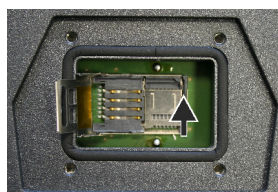

4. - Lift the bracket for the SIM card upwards.

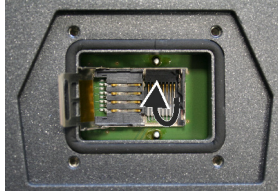
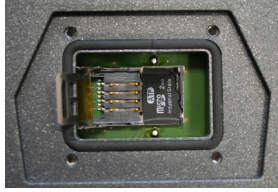
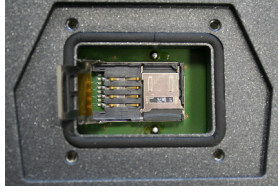
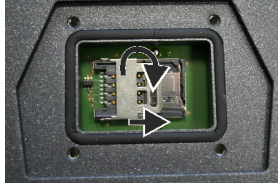

5. - Release the bracket for the SD card by gently sliding it in the direction of the arrow.

6.  - Lift the bracket for the SD card upwards.
  7.  - Insert the SD card.
  8.  - Fold the bracket for the SD card down and lock it in position.
  9.  - Fold the bracket for the SIM card down and lock it in position.
  10.  - Screw the cover back onto the rear of the terminal.
- ⇒ You have inserted the SD card.

## 4.4

### Inserting micro-SD card

The terminal must be equipped with a SIM card so that you can use the farm pilot portal. If you do not intend to use the farm pilot portal, you will not need any SIM card.

#### Which SIM card?

You must purchase the SIM card from your mobile phone provider.

Select a mobile phone provider that can guarantee good mobile phone reception on your fields. A good connection is required in order for work with the farm pilot portal to run smoothly.





The SIM card must meet the following requirements:

- It must be GPRS-capable.
- It must be PIN-free. Inform your mobile phone provider about this requirement before purchasing the SIM card.
- The contract must enable data transfer.

#### Procedure

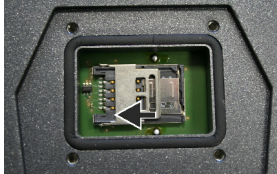
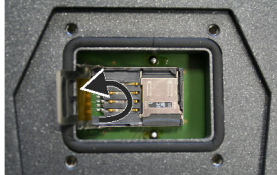
Insert the SIM card as follows:

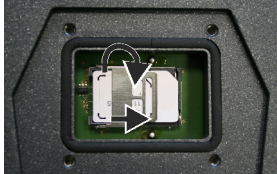
1. Switch off the terminal and disconnect all cable connections.

2.  - Unscrew the cover on the rear of the terminal.
  3.  - Release the bracket for the SIM card by gently sliding it in the direction of the arrow.
  4.  - Lift the bracket for the SIM card upwards.
  5.  - Insert the SIM card.
  6.  - Fold the bracket down, and lock it in position.
  7.  - Screw the cover back onto the rear of the terminal.
- ⇒ You have inserted the SIM card.

## 4.5 Using two terminals

The following table will tell you which settings you need to configure to be able to use two terminals, and the sections in which these are described. The specifications on the in-cab terminals are without liability.

**Settings for the ME terminal and in-cab terminal**

Possible purpose	Setting of the ME terminal	Setting of the in-cab terminal
<p>TRACK-Leader and SECTION-Control on the ME terminal.</p> <p>Operation of the job computer on the in-cab terminal.</p>	<p>Login as ISOBUS terminal: No [→ 52]</p>	<p>Activate the ISOBUS terminal (JohnDeere: Implement Bus; Fendt: Fendt ISOBUS terminal).</p> <p>Deactivate Task Controller (JohnDeere: Task Controller; Fendt: Taskcontroller).</p>
<p>TRACK-Leader, SECTION-Control, and job computer operation on the ME terminal.</p>	<p>Login as ISOBUS terminal: Yes [→ 52]</p>	<p>Deactivate the ISOBUS terminal (JohnDeere: Implement Bus; Fendt: Fendt ISOBUS terminal).</p> <p>Deactivate Task Controller (JohnDeere: Task Controller; Fendt: Taskcontroller).</p> <p>For JohnDeere, also deactivate: Greenstar, Original Greenstar</p>

## 5 Basic control principles

### 5.1 Switching on the terminal

**Procedure**

To switch on the terminal:

- The terminal is installed and connected to the ISOBUS basic vehicle harness.

1. Press and hold the  button for approx. 3 seconds.

- ⇒ The terminal will beep briefly.
- ⇒ The terminal screen remains dark for approx. 10 seconds until the applications are loaded in the background.
- ⇒ The Start screen of the terminal appears:

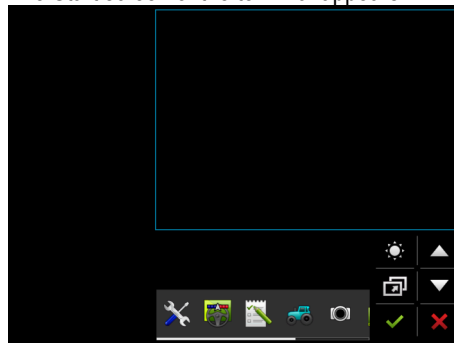

⇒ You have started the terminal.

### 5.2 Initial start-up

The next step to perform after switching on the terminal depends on the purpose of the terminal:



- Parallel driving
- Operation of ISOBUS implements
- Automatic section control
- Task management and documentation

These cases will be described in the following sections.

#### 5.2.1 Using the terminal for parallel driving

If you want to use the terminal for parallel driving, TRACK-Leader is the most important app for you.

**Most important settings**

Setting	Where?	Purpose
Select the GPS driver.	 / Driver / GPS [→ 32]	The standard driver works in most cases for the receivers sold by ME. However, to change the correction signal, a fitting driver for the GPS receiver must be activated.
Enter the tractor geometry and activate the tractor profile.	 / Settings	See: - Managing the tractor profiles [

Setting	Where?	Purpose
		→ 58] - Tractor geometry [→ 63]
Virtual job computer	 / Settings	For the system to be able to know the working width and other parameters of the machine, you must create a virtual job computer for every non-ISOBUS-compatible machine that you use.  See: Virtual ECU application [→ 68]

Other settings must be made in the TRACK-Leader application.

## 5.2.2 Operating ISOBUS implement



To operate an ISOBUS job computer with the terminal, it is sufficient to connect the job computer to the rear ISOBUS socket. As a standard, the terminal disposes of the required licences.

### Procedure

- The "ISOBUS-UT" licence is activated.
- 1. Insert the ISOBUS cable of the job computer into the ISOBUS rear socket.
- 2. Switch on the terminal.
- 3. Wait until the job computer application has copied all of the relevant data on the terminal.
- 4. Open the job computer application using the selection menu [→ 26].

## 5.2.3 Terminal for automatic section control

### Most important settings

Setting	Where?	Commentary
Select the GPS driver (optional).	 / Driver / GPS [→ 32]	The standard driver works in most cases for the receivers sold by ME. However, to change the correction signal, a fitting driver for the GPS receiver must be activated.
Enter the tractor geometry and activate the tractor profile.	 / Settings	See: - Managing the tractor profiles [→ 58] - Tractor geometry [→ 63]
Connecting the job computer to the ISOBUS.		

Setting	Where?	Commentary
Job computer profile in SECTION-Control	 / Settings / SECTION-Control	Search for a profile and set the "Machine model" parameter.  For more precise operation, configure all of the other parameters in the profile.

**Procedure**

The "ISOBUS-UT", "TRACK-Leader" and "SECTION-Control" licenses are activated.

1. Insert the ISOBUS cable into the ISOBUS rear socket.
2. Switch on the terminal.
3. Wait until the job computer application has copied all of the relevant data on the terminal.



4.  - Open the TRACK-Leader application using the selection menu [→ 26].

5. Configure the settings from the table above.
6. Start a new navigation.

You can read how to proceed in the operating instructions for TRACK-Leader.

**5.2.4****Terminal for task management**

You can always use ISOBUS-TC task management, regardless of whether you are driving in parallel, switching sections or simply operating an ISOBUS job computer. However, the most important settings mentioned in the previous sections must be made for each of these applications.

Important for ISOBUS-TC:

- Always remember to start and stop the tasks.
- After finishing work, you must save all of the tasks on the USB memory device (log out the USB memory device) before you remove the USB memory device or transmit new tasks onto the terminal.

**Most important settings**

Setting	Where?	Purpose
Set the operating mode to "Extended".	 / Settings	Activates and deactivates task management in the ISOBUS-TC application.  If you do not want to create tasks, set the operating mode to "Standard".
Insert the USB memory device with task data or create tasks without a USB memory device.		

**Procedure**

The "ISOBUS-TC" licence is activated.

1. Switch on the terminal.





2. - Open the ISOBUS-TC application using the selection menu [→ 26].
3. Insert a USB memory device with task data.
4. Start a task.

## 5.3

### Switching off the terminal

#### Procedure

To switch off the terminal:

1. Press and hold the  button for approx. 3 seconds.  
⇒ You have now switched off the terminal.

## 5.4

### Terminal screen layout

Depending on the layout you are using [→ 50], the areas of the screen will be arranged differently. The examples in this and in the following sections show the layout in landscape format:

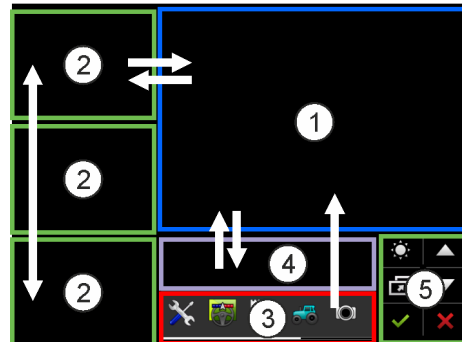

Terminal screen layout

①	<p><b>Main window</b> This area enables you to operate applications. Touching the terminal screen in the “Main window” area will actuate the function whose icon you have touched. The controls depend on the opened applications.</p>	④	<p><b>ME Header</b> In this area, ISOBUS job computers made by Müller-Elektronik can display a summary of information on the status of the agricultural implement. The area can also be used as an additional window.</p>
②	<p><b>Additional window</b> In the three lateral, superimposed additional windows, you can allow applications to be displayed which you want to see but do not want to use.</p>	⑤	<p><b>System icons</b> See the table below.</p>
③	<p><b>Selection menu</b> You can open applications in the “Selection Menu” area.</p>		

#### System icons

Icon	Meaning
	<p>Changes the brightness for day and night.</p>

Icon	Meaning
	Changes the arrangement of the applications in the windows.
	Has no function in this area. When this icon appears in other areas, it is used for confirmation purposes.
	Has no function.
	Has no function.
	Has no function in this area. When this icon appears in other areas, it is used for cancellation or deletion purposes.

## 5.5

### Opening applications

An application opens when it appears in the main window or in an additional window.

#### Procedure

To open an application:

1. Find the function icon for the desired application in the Selection menu area. For example, the



2. Tap the function icon of the application:

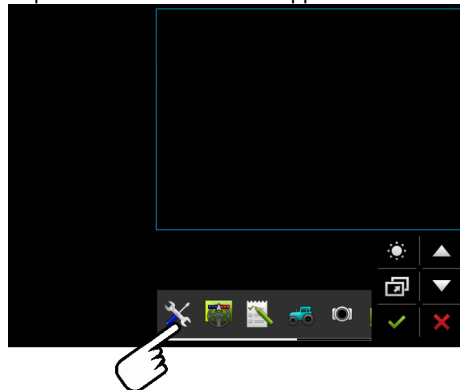

⇒ The application appears in the main window:

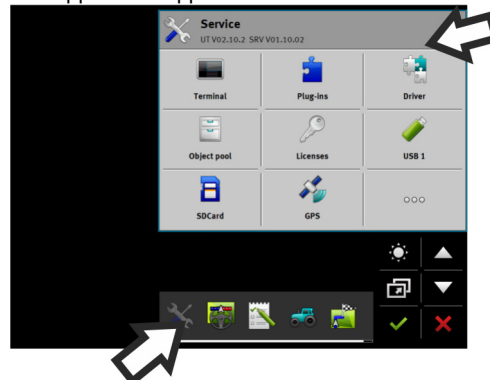

- ⇒ The function icon of the application in the Selection menu now appears darker. This tells you that this application is already open. You will no longer be able to open it from the Selection menu.
- ⇒ If the main window is occupied, the application that is already opened will be moved to a free additional window. If this is occupied, the application that is already opened will be moved back to the Selection menu. Their icon becomes bright again. However, it can continue to work in the background.

## 5.6 Moving an application

You can move any application from the main window to one of the additional windows or to the ME-Header.

### Procedure

To move an application from the main window to an additional window:

- You have opened an application in the main window. For example, the Service application:

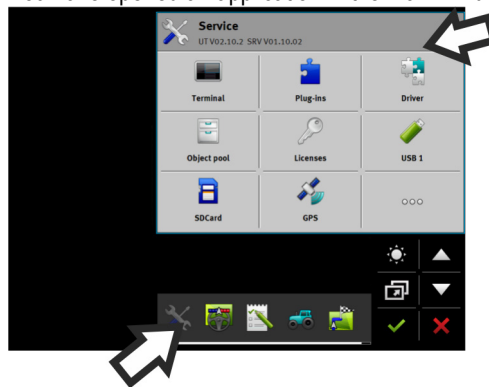

1. Tap the additional window:

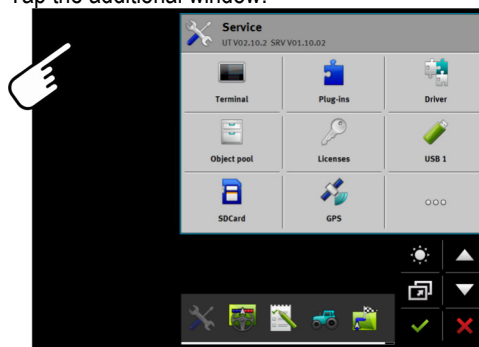

- ⇒ The application will now appear in the additional window:

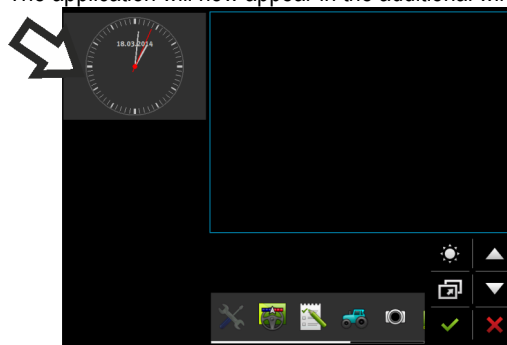

2. Tap the additional window with the application.
  - ⇒ The application will once again appear in the main window.

## 5.7

## Moving open applications

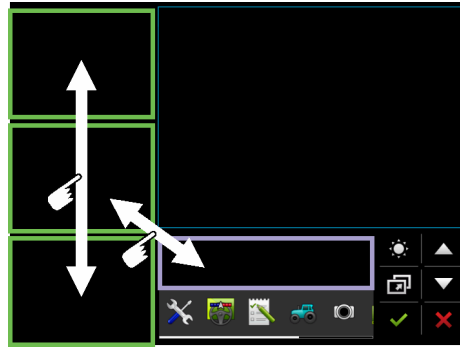

You can move applications between additional windows and the ME-Header.

## Procedure

To move an application between additional windows:

- An application appears in the additional window:

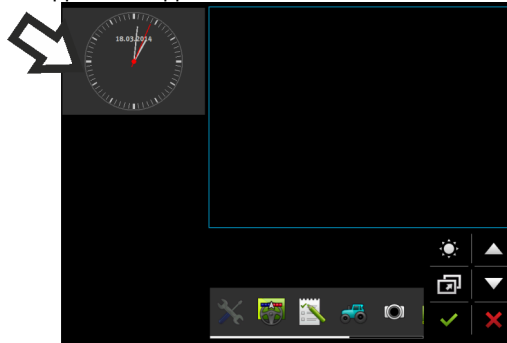

1. Use your index finger to move the image of the application downwards. You must touch the terminal screen the entire time:

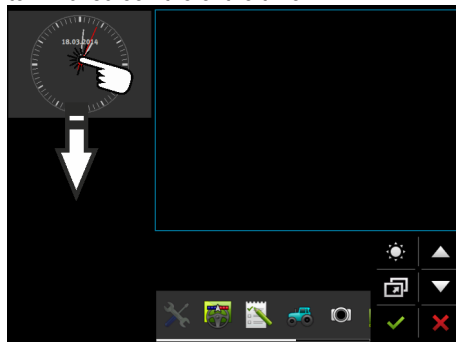

⇒ The additional window in which the application will then be displayed is marked in green.

2. Move your finger away from the terminal screen.

⇒ The application will now appear in the other additional window:

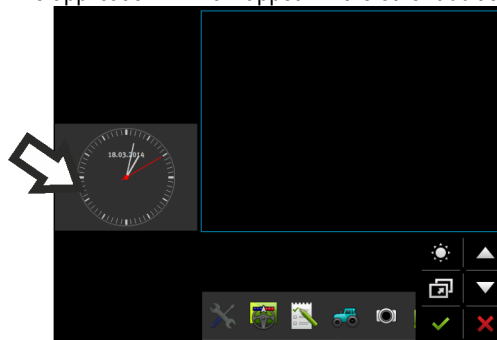

## 5.8 Saving and loading window arrangements

You can save and load the arrangement of the applications in the windows.

### Procedure

To save the arrangement:

1. Hold the button  pressed down until the terminal beeps twice.  
⇒ The arrangement will be saved.

### Procedure

To load a saved arrangement:

1. Briefly press the button:   
⇒ The arrangement will be loaded.

## 5.9 Hiding an application

If you do not have enough space on the terminal screen to open new applications, you can hide an application. The application will not be shut down, but will instead continue to run in the background.

### Procedure







To hide an application:

1. Open the application in the additional window.
2. Move the application to the selection menu.

## 5.10 Using the keyboard

In order to enable you to also write numbers or text on the terminal, a keyboard appears on the terminal screen whenever this is necessary.

### Major icons

Icon	Meaning
 12# Abc	Changes the buttons on the keyboard.
	Deletes a character.
	Moves the cursor.
	Saves the input.
	Cancel the input.
	Switches between upper and lower case letters.



Keyboard for inputting text and numbers.

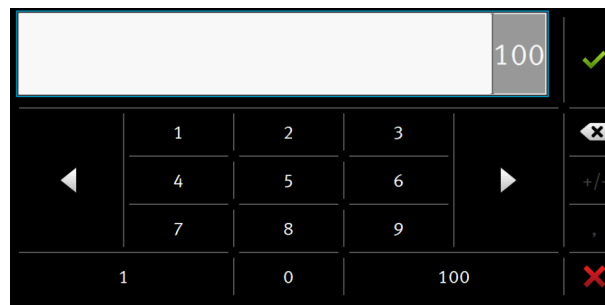

Keyboard for inputting text.

## 5.11

### Using a memory device

The terminal can work with two kinds of memory devices:

1. With an integrated micro-SD card. This will be used as storage for most applications.
2. With an inserted USB memory device.

The USB memory device is used only for the following purposes:

- For data transfer [→ 30] between the terminal and PC
- For saving screenshots

#### farmpilot

If you use the farmpilot portal, do not use a USB memory device, but only the SD card.

### 5.11.1

#### Using SD card

The terminal applications save most data [→ 30] directly onto the SD card.

In order to exchange data between the terminal and a PC, you will need to proceed differently for each application. You can find out more about this in the instructions for each application.

### 5.11.2

#### Folders on the USB memory device

As soon as you insert the USB memory device into the terminal, several folders will be created on the USB memory device. You will need to set up other folders by yourself.

Each folder may only contain certain data, so that the applications on the terminal can use this data.

- “documents”
  - Files: .txt
  - Purpose: Records for all completed tasks are saved in this folder.
- “FIELDNav”
  - Files: .iio, .data

- Purpose: Map material will be saved in this folder.
- The folder will be created when the FIELD-Nav license is activated.
- “fileserver”
  - Files: All file formats are acceptable.
  - Purpose: Files which are to be imported or exported in the FILE-Server application are saved in this folder.
- “GPS”
  - Files: .txt
  - Purpose: GPS positions are saved in a file in the folder. This will enable Customer Service to reconstruct the traveled distance.
  - The folder will be created if you activate the “Record and save data” parameter.
- “NgStore”
  - Files: .iio, .data
  - Purpose: TRACK-Leader. Standard folder for saved routes and fields.
- “Screencopy”
  - Files: .bmp
  - Purpose: Screenshots are saved here.
  - The terminal will create this folder automatically when the “Screenshot” parameter is activated in the “Terminal” menu and you create a screenshot.
- “SHP”
 

This folder replaces the “GIS” folder that was used in previous versions.

  - Files: .dbf, .kml, .prj, .shp, .shx
  - Purpose: TRACK-Leader: After saving with the SD card, the field data will be stored here. For example: Field boundaries, applied areas, headlands, etc.  
ISOBUS-TC: The shp files must be stored in this folder.
- “Taskdata”
  - Files: .xml
  - Purpose: The folder may only contain XML files which originate from an ISO-XML compatible FMIS. The ISOBUS-TC application accesses this data.
  - You must create this folder yourself.

### 5.11.3

### Displaying the content of the memory device on the terminal

You can view the content of the memory device directly on the terminal.

#### Procedure

1. Insert the memory device (USB memory device or SD card) into the terminal.
  2. Open the “Service” application.
  3. Tap on “USB 1” or on “SDCard”.
- ⇒ The content of the USB memory device will be displayed.
- ⇒ The content of the SD card can be found in the “ME-TERMINAL” folder.

## 6 Connecting and configuring external devices

### 6.1 GPS receiver

#### 6.1.1 Connecting the GPS receiver to the terminal

Find out how to connect a GPS receiver from Müller-Elektronik to the terminal from the operating instructions for the GPS receiver.

When mounting the terminal in a vehicle which is already fitted with a GPS receiver and another ISOBUS terminal, you must:

- connect the GPS signal to the terminal manufactured by Müller-Elektronik.
- configure the GPS receiver.

#### Procedure

To connect the terminal to a GPS receiver which is already installed on the vehicle:

1. Find out how you can direct the signal from the GPS receiver to the terminal. This can differ for every vehicle or GPS receiver: Vehicles can be fitted with a GPS socket in the cab, a GPS receiver with a serial output or serial outputs to the ISOBUS terminal.
2. Check what cable you will use to connect GPS signal to the serial socket on the terminal manufactured by Müller-Elektronik.
3. Connect the GPS signal to the serial socket of the terminal manufactured by Müller-Elektronik.
4. Configure the GPS receiver so that it can communicate with the terminal manufactured by Müller-Elektronik. You can find the necessary specifications for this in the table below.
5. Activate the "Standard" GPS driver on the terminal.

#### Configuration

Frequencies	5 Hz (GPGGA, GPVTG)
	1 Hz (GPGSA, GPZDA)
Transmission rate	19200 baud
Data bits	8
Parity	No
Stop bits	1
Flow control	None

#### 6.1.2 Changing the driver for the GPS receiver

Upon delivery, the "Standard" driver is activated on the terminal. You must change this driver if you want to reconfigure the GPS receiver, for example, to change the correction signal. In this case, you must select a driver that is fitting for the GPS receiver.



**Available drivers**

Driver name	GPS receiver
deactivated	No GPS receiver is connected.
A100, A101	Drivers for the A100 and A101 GPS receivers from Müller-Elektronik, if they are connected to the serial interface.
AG-STAR, SMART-6L	Drivers for the AG-STAR and SMART-6L GPS receivers from Müller-Elektronik, if they are connected to the serial interface.
PSR CAN	Select this driver if the GPS receiver is connected to the PSR steering job computer. PSR is a steering job computer by the Reichhardt company. The signals are transmitted to the terminal through the CAN cable. The receiver will be configured directly in the PSR application.  Please note that you cannot use this driver together with an external lightbar.
Standard	Drivers for unknown GPS receivers, if they are connected to the serial interface.  This driver is activated by default. The connected GPS receiver cannot thus be configured.
TRACK-Leader AUTO®	Select this driver if a GPS receiver is connected to the TRACK-Leader AUTO® steering job computer.  Please note that you cannot use this driver together with an external lightbar.

**NOTICE**



**Incorrect driver**

Damage to the GPS receiver.

- Before connecting a GPS receiver to the terminal, you must always activate the appropriate driver.

**Procedure**

To activate the driver:





1.  - Open the "Service" application.
2. Tap "Driver".
3. Tap "GPS".  
⇒ The installed drivers appear.
4. Tap the appropriate driver.
5.  - Confirm.
6. Restart the terminal.

### 6.1.3 Configuring the GPS receiver

The internal software for each GPS receiver must be configured. You can configure the following GPS receivers offered by Müller-Elektronik via the terminal:

- A100, A101
- AG-STAR, SMART-6L

All other GPS receivers must be configured in accordance with their manufacturer's instructions.

Function icon	Meaning
	Reads the configuration of the GPS receiver.
	Restores the manufacturer's default settings.
	Opens the license menu. Only appears on SMART-6L DGPS/GLONASS receivers for entering an activation license.
	Resets the baud rate.

#### Procedure

- The GPS receiver is connected to the terminal.
- The GPS receiver is connected directly to the terminal. Additional devices such as an external lightbar or tilt module may **not** be connected in between.
- The correct GPS driver is activated.



1.  - Open the "Service" application.
2. Tap "GPS".
  - ⇒ The "Settings" screen appears.
  - ⇒ The following message appears during initial configuration: "GPS receiver detected. Read the configuration?"
3. To confirm, tap "Yes". To cancel, tap "No".
  - ⇒ The terminal reads the current configuration of the GPS receiver.
  - ⇒ You can now see all of the configurable parameters.
4. Configure the parameters. The parameters can be found in the following section.
5. Reconnect all of the additional devices that you had disconnected for the configuration.

#### Parameters for the GPS receiver

##### Baud rate

Only appears when the "Standard" driver is selected.

Setting for the speed at which the GPS receiver sends data to the terminal. The parameter sets the baud rate for the terminal.

##### Satellite 1 and Satellite 2

Satellite 1 – primary DGPS satellite. The DGPS receiver will connect to this satellite in the first instance.

Satellite 2 – secondary DGPS satellite. The DGPS receiver will only connect to this satellite in the event that the primary satellite fails.

Your satellite selection will depend on which satellite currently has the best availability in your region.

Possible values:

- “Auto”  
The software automatically selects the current best satellite.
- Name of the satellite. Which satellites are shown here is dependent on the driver and correction signal that you have activated.

### Steering

This parameter activates the “Automatic steering” assistance function in the GPS receiver.

If you want to connect your existing GPS receiver to a steering job computer, you have to configure the “Steering” parameter.

Possible values:

- “Without automatic steering”  
Deactivates automatic steering assistance.
- “TRACK-Leader TOP”  
Activates automatic steering assistance with TRACK-Leader TOP.
- “TRACK-Leader AUTO”  
Activates automatic steering assistance with TRACK-Leader AUTO.

### Correction signal

Type of correction signal for the DGPS receiver.

The correction signals which are available is dependent on the activated driver.

Possible values:

- For the “A100, A101” driver:
  - “WAAS/EGNOS”  
Correction signal for Europe, North America, Russia and Japan.
  - “E-DIF”  
Internal calculation of correction data.  
Only functions with a special version of the A100 DGPS receiver, item no. 30302464. This receiver is no longer sold by Müller-Elektronik.
- For the “AG-STAR, SMART-6L” driver  
When a DGPS/GLONASS AG-STAR receiver is connected:
  - “EGNOS-EU”
  - “WAAS-US”
  - “MSAS-JP”
  - “EGNOS-EU + GLIDE”
  - “WAAS-US + GLIDE”
  - “MSAS-JP + GLIDE”
  - “GPS/GLONASS GLIDE 1”

- “GPS/GLONASS GLIDE 2”

When a DGPS/GLONASS receiver SMART-6L receiver is connected:

- EGNOS/WAAS
- EGNOS/WAAS + GLIDE
- GLIDE
- RTK radio(RTK licence required)
- RTK GSM(RTK licence required)
- TerraStar (RTK or L band licence required)

### Information for GLIDE

If you have selected a correction signal with GLIDE, please note:

- Switch the GPS receiver off when driving on roads.
- After starting the systems each time, it takes ca. 5 minutes until the system is ready for operation. Wait on the field to be worked during this time, before you start working.
- Ensure that the GPS receiver does not lose the GPS signal during work. (e.g. due to shadowing by buildings or trees). If the signal gets lost, it can cause the GLIDE to restart. This can lead to track offset.

### Information for TerraStar

If you have selected “TerraStar” as a correction signal, please note:

- There are two different TerraStar correction signals: TerraStar-C and TerraStar-L. These differ mainly in their accuracies.
- The accuracies are available ca. 5 to 10 minutes after switching on the GPS receiver under the open sky.
- If the GPS signal fails due to shadowing by buildings or trees, the full accuracy is available again at the latest after ca. 5 minutes. For this reason, you should avoid driving along rows of trees or buildings.
- During the convergence, the GPS receiver and the vehicle should not be moved and the location should not be changed.

### Baud rate of the receiver on port B

Only appears when the “RTK radio” correction signal is selected.

If you are using a GPS receiver with a radio modem from a third-party manufacturer, the baud rate must be adjusted in some cases. The baud rate must then correspond to that of the radio modem. The baud rate for radio modems manufactured by Müller-Elektronik is always 19.200 baud.

### Correction during RTK failure

This parameter is only required if you are using the SMART-6L DGPS receiver with a steering system.

Possible values:

- automatic

The parameter is activated.

When there is an RTK failure, a deviation arises between the current position of the vehicle and the GPS position.

If the parameter is set to “automatic”, you prevent the vehicle from driving directly to the new GPS position. The system will then gradually steer towards the new GPS position. This prevents the occurrence of large track offsets in case of RTK failure.

When the RTK signal is available again, the vehicle will be gradually steered towards the original GPS position.

- deactivated  
The parameter is deactivated.

#### Tilt module

The GPS TILT-Module is configured using this parameter.

You can order the tilt module from Müller Elektronik with the following item number: 30302495.



#### RTK or L band licence for SMART-6L

You will need a SMART-6L DGPS/GLONASS receiver and RTK license in order to work with RTK correction signals.

To work with TerraStar correction signals, you need a SMART-6L DGPS/GLONASS receiver and at least an L band license.

When purchasing a GPS receiver with an RTK or L band license, the licence from Müller-Elektronik will be entered. You only have to enter the licence yourself when it is purchased at a later date.

#### Procedure



1.  - Open the “Service” application.
2. Tap “GPS”.  
⇒ The “Settings” screen appears.
3.  - Open the license menu.
4. Tap “License code”.  
⇒ The “License menu” screen appears.  
⇒ You can see the serial number and firmware version on the screen. You will need these when ordering the license code.  
⇒ If you are using the TerraStar correction signal, you will see information on the TerraStar service and the expiry date of the TerraStar service.  
⇒ Optionally, you can open the “Model number” screen to obtain information on the current activation of the GPS receiver.
5. Enter the license code.
6.  - Confirm.

#### GSM modem for SMART-6L

If you are using the DGPS/GLONASS SMART-6L receiver with a GSM modem, you can adjust the existing configuration.

#### Procedure

1.  - Open the “Service” application.
2. Tap “GPS”.
3. The “Settings” screen appears.

4.  - Open the configuration menu.
5. Configure the parameters. The explanations for the individual parameters can be found in the table at the end of this section.
6.  - Save the changes.
  - ⇒ The following message appears: “Should the data be transmitted to the modem?”
7. “Yes” - to confirm.
  - ⇒ The data is being transmitted to the modem. This will take approx. 30 seconds.

Parameter	Meaning	Possible entries
APN	Connection to the provider.	Provider URL or IP address.
User	Name for the Internet access. The name is the same for all users of a provider.	Name that was given by the provider. Some providers do not require entering a name.
Password	Password for the Internet access. The password is the same for all users of a provider.	Password that was given by the provider. Some providers do not require entering a password.
URL/IP	Connection to the correction data server.	Correction data server URL or IP address.
Port	Port at the correction data server.	Port number
NTRIP user	Name from the correction service to identify the customer account.	Letters and numbers. Pay attention to the use of upper and lower case letters.
NTRIP password	Password for the identification name.	Letters and numbers. Pay attention to the use of upper and lower case letters.
Mountpoint	Manual entry of a correction data source available only with GPRS connections.	Name of the correction data source / data stream.

### Configuring the GPS receiver for the steering system

To be able to use a GPS receiver with automatic steering, it must previously be configured for this use. The configuration adjusts the internal settings of the GPS receiver.



You can use the following GPS receivers for the steering system:

- A101
- AG-STAR
- SMART-6L

#### Procedure



To configure the GPS receiver for automatic steering:

1. Activate the driver for the respective GPS receiver [→ 32] to establish a connection between the terminal and the GPS receiver.
2. Configure the GPS receiver. [→ 34]
3. Tap “Steering” in the configuration.
4. Select the automatic steering that you are using.

5.  - Confirm.
6. For TRACK-Leader AUTO® systems, tap  and adjust the baud rate of the receiver to the automatic steering.  
⇒ The following message appears: “You can now disconnect the GPS receiver.”
7. Confirm using “OK”.
8. Switch off the terminal.
9. Now connect the GPS receiver to the cable harness of the steering job computer.
10. Start the terminal.
11. Depending on the steering job computer, activate the “PSR CAN” or “TRACK-Leader AUTO” driver. [→ 32]
12.  - Confirm.
13. Restart the terminal.  
⇒ The GPS receiver is now configured for automatic steering.

To change parameters for the GPS receiver after the GPS receiver has been configured for automatic steering, you must restore the internal settings of the GPS receiver.

#### Procedure

1. Connect the GPS receiver to the terminal.
2. Activate the driver for the respective GPS receiver. [→ 32]
3. Restart the terminal.
4.  - Open the “Service” application.
5. Tap “GPS”.
6.  - Reset the baud rate.
7. The following message appears: “Should the standard baud rate be restored?”
8. Confirm using “OK”.
9. Restart the terminal.  
⇒ You can now change the individual parameters for the GPS receiver.  
⇒ After you have changed the parameters, you can reconfigure the GPS receiver for the steering.

#### 6.1.4

#### Recording GPS position

Certain faults can require recording of the position data from the GPS receiver.

#### Procedure



- A USB memory device is inserted into the terminal.
1.  - Open the “Service” application.
  2. Tap “GPS”.
  3. Tap “GPS data”.  
⇒ The “GPS data” screen appears.

4. Scroll down.
5. Tap "Trace data".
  - ⇒ The "Trace data" screen appears.
6. Scroll down.
7. Checkmark the "Record and save data" button.
  - ⇒ The terminal will immediately begin to record the data. This will be saved in the "GPS" folder on the USB memory device.
  - ⇒ The function will be deactivated following any restart.

## 6.1.5

### Configuring the "GPS TILT-Module" tilt module

#### Procedure

- The "GPS TILT-Module" tilt module is connected.
  - The tractor is positioned on level ground.
  - The lightbar driver is configured as a "screen lightbar".
1. If additional devices (e.g. external lightbar) are connected to the cable between the terminal and the tilt module, disconnect them. The tilt module must be connected directly to the terminal. After the tilt module has been configured, these additional devices must be reconnected.
  2. Measure the distance between the GPS receiver and the ground on which the tractor is positioned.
  3. Switch on the terminal.
  4.  - Open the "Service" application.
  5. Tap "GPS".
    - ⇒ The "Settings" screen appears.
  6. Scroll down until the "Tilt module" parameter appears on the screen.
  7. Tap "Tilt module".
  8. Enter the measured distance on the "GPS receiver height" line.
  9. Tap .
    - ⇒ Message: "Tilt module will be configured." is displayed.
  10. To confirm, tap "Yes".
    - ⇒ The position of the tilt module on level ground is being calibrated.
    - ⇒ After calibration, the angle 0 will appear on the "Angle" line. The displayed angle will change with any tilt of the tractor.
  11. Reconnect all of the additional devices that you had disconnected for the configuration.

## 6.2

### Configuring the joystick button allocations

The terminal offers you the possibility of assigning the functions of an ISOBUS job computer to the buttons of the joystick. To do so, the ISOBUS job computer and the joystick must fulfil the Auxiliary 2 specification requirements from the ISOBUS standard.

#### Procedure

To activate the driver for this function:

- The joystick and ISOBUS job computer are connected and both support the Auxiliary 2 protocol.





1. - Open the "Service" application.
2. Tap "Driver".
3. Tap "Auxiliary".
4. Mark "Auxiliary2".



5. - Confirm.
6. Restart the terminal.

## Procedure

To configure the button assignment:

- You have activated the "Auxiliary2" driver



1. - Open the "Service" application.
2. Tap "Auxiliary".
3. Tap "Auxiliary Editor".
  - ⇒ If the ISOBUS job computer supports the Auxiliary 2 protocol, a list appears of the job computer functions.
  - ⇒ If no list appears, the ISOBUS job computer does not support this protocol.
4. Tap the function which you want to assign to this button on the joystick.
  - ⇒ A list of the buttons on the joystick appears.
  - ⇒ You have two options for assigning the function to the joystick.
5. **Option 1:** On the joystick, press the button to which you want to assign the function.  
**Option 2:** On the terminal, select the button to which the selected function should be assigned  
 and confirm with .
  - ⇒ The function will be assigned to the button and you can continue with the next function, until you have assigned all of the functions.
6. Restart the terminal.
  - ⇒ After restarting, the following notification appears on the main terminal screen: "Confirm the assignments." This notification appears after any restart.
7. "OK" - acknowledge the notification.
  - ⇒ A list of recognized assignments appears on the terminal screen.
8. - Confirm the assignments.

## 6.3

### Connecting sensors to the terminal

The terminal provides you with the possibility of connecting a sensor or the tractor's 7-pin signal socket to port B. This allows you for example to use the work position signal in the TRACK-Leader parallel guide.

The work position sensor sold by Müller-Elektronik is fitted with a round 3-pin connector. You will need an adapter cable to connect it to the terminal.

**Adapter cable for the ME sensor Y work position sensor**

Adapter cable	Item number
3-pin to 9-pin	31302499

You can also connect the terminal to the signal socket.

**Cable to the signal socket**

Ports	Connection	Item number
7-pin to 9-pin socket	Cable directly to the signal socket Transmits the speed and work position.	30322548

You must activate the work position sensor [→ 61] and possibly the wheel sensor [→ 60] or radar sensor in the Tractor-ECU app and calibrate if necessary.

**6.4**

**Camera**

**6.4.1**

**Connecting the camera to the terminal**

**Connecting the camera HQ2**



Camera HQ2 - Connection to TOUCH1200

①	Connector for connection to the terminal. <b>Port D</b>	③	Camera HQ2
②	Extension cable	④	Camera connector
		⑤	Connector for the camera plug

**Procedure**

1. Assemble the camera together with its bracket, as described in the assembly instructions of the camera manufacturer.
2. Connect the camera to the extension cable.
3. **CAUTION! When laying out the extension cable, ensure that there are no kinks and that no one can stumble over the laid-out cable.**
4. Connect the extension cable to **port D** of the terminal.
5. Secure the camera.
6. Activate the camera. [→ 43]

### Connecting the camera NQ



Camera with adapter cable

①	Connector for connection to the terminal. <b>Port D</b>	④	Camera
②	Connector for the adapter cable	⑤	Camera connector
③	Connector for the extension cable	⑥	Connector for the camera plug

#### Procedure

1. Connect the cables to each other as shown in the figure. Pay attention to cable lengths when doing so.
2. **CAUTION! When laying out the cable, ensure that there are no kinks in the cable and that no one can stumble over the laid-out cable.**
3. Lay out the cable. Ensure that the cable reaches the terminal and is not pulled out during operation.
4. Attach the cable with the provided cable ties.
5. Secure the camera. Use the white cardboard drilling template from the quick start guide for this purpose.
6. Connect the camera to the terminal. Use connector D to do this.
7. Activate the camera. [→ 43]
8. When disconnecting the cable from the terminal, use the enclosed rubber gasket to seal the exposed connector.

### 6.4.2

#### Activating a camera

In order to activate a camera, you must activate the “Camera\_ME” plug-in.

#### Procedure

1.  - Open the “Service” application.
2. Tap “Plug-ins”.
3. Tap “Camera”.  
⇒ The plug-in is marked with a green tick.
4. Restart the terminal.

⇒ After restarting, the icon for the camera application appears in the selection menu.



5.  - Open the Camera application.

### 6.4.3 Operating the camera

The camera serves **solely** for observing the implement functions in non-safety-related working areas of the agricultural implement.

In certain situations, the camera image may appear on the screen with a delay. The delay depends on the respective use of the terminal and can also be affected by external factors and devices.

	<p><b>! WARNING</b></p>
	<p><b>Accident due to delayed image transmission</b> Rapidly moving objects may be detected too late.</p> <ul style="list-style-type: none"> <li>◦ Do not use the camera as an aid for steering the vehicle.</li> <li>◦ Do not use the camera in road traffic.</li> <li>◦ Do not use the camera when driving into intersections.</li> <li>◦ Do not use the camera as a rear view camera.</li> <li>◦ Do not use the camera as a visual aid for controlling the implement, especially when a delayed reaction can lead to risks.</li> </ul>

Function icon	Meaning
	Mirrors the image horizontally.
	Mirrors the image vertically.

- You have connected and activated the camera.

1.  - Open the Camera application.  
⇒ The filmed image appears in the main window.
2. Tap on the main window.  
⇒ Function icons appears on the side for 10 seconds, with which you can actuate the camera.

## 6.5 External lightbar

### 6.5.1 Connecting the external lightbar to the terminal

The external lightbar is a parallel driving display made by Müller-Elektronik, which can be mounted near the windshield.

The external lightbar works with position data and guidance lines that are provided by the TRACK-Leader app. This is why you need the TRACK Leader App to be able to use the external lightbar.

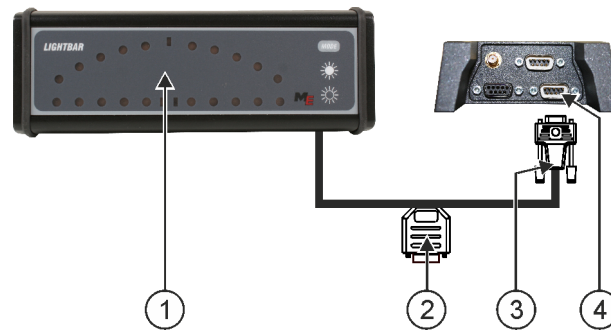

①	External lightbar	③	Connector for connection to the terminal
②	Connector for connecting a GPS receiver	④	Serial port

## 6.5.2



### Activating an external lightbar

If you connected an external ME Lightbar to the terminal, you must activate it.

To activate the external lightbar, you must first activate its driver.

You can order the external lightbar from Müller-Elektronik with the following item number: 30302490.

#### Procedure

1.  - Open the "Service" application.
2. Tap "Driver".
3. Tap "Lightbar".  
⇒ The installed drivers appear.
4. Tap "Lightbar".
5.  - Confirm.
6. Restart the terminal.

## 6.6

### Connecting the on-board integrated display/controller to the terminal

You can connect a range of on-board integrated display/controllers (non-ISO computers), which communicate using the LH5000 protocol or the ASD interface, to the terminal.

An appropriate connector cable for each on-board integrated display/controller which can be connected is available from Müller-Elektronik. Our sales team will be glad to advise you.

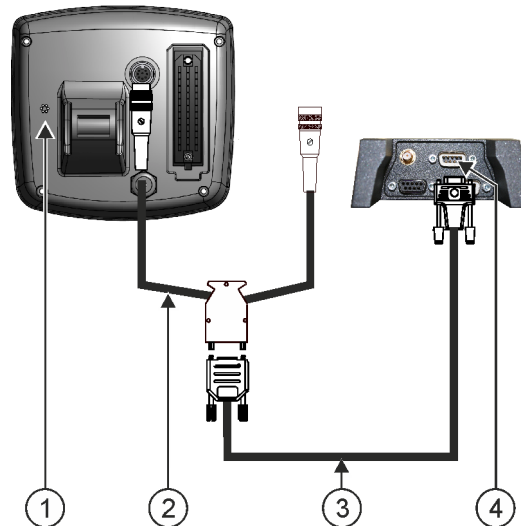

①	On-board integrated display/controller	③	Null modem cable
②	Adapter cable* Available as a set with Cable 3, item number: 3032254800	④	Connector B of the terminal

\*When using an Amatron3 or Amatron+ as on-board integrated display/controller, you will only need a traditional null modem cable. (Amatron3 and Amatron+ are on-board integrated display/controller from Amazone)

**Procedure**

1. After connecting the on-board integrated display/controller to the terminal, create a virtual job computer for the machine. More about this in section: Virtual ECU application [→ 68]

## 6.7 ISO Printer

### 6.7.1 Connecting the ISO printer to the terminal

The ISO printer is used to print out information from an ISO-XML task.

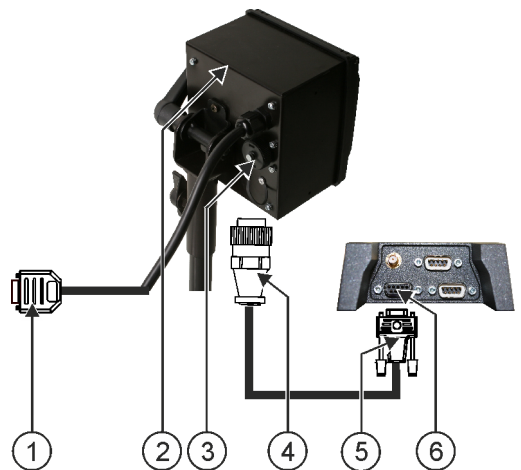



①	9-pin Sub-D connector for connection to ISOBUS	④	Connector for connection to ISO printer socket
②	ISO Printer	⑤	Connector for connection to the terminal
③	ISO Printer socket	⑥	CAN Bus port

## 6.7.2 Activating ISO Printer

In order to activate the ISO printer, you must activate its driver.

### Procedure

1.  - Open the "Service" application.
2. Tap "Driver".
3. Tap "ISOPrinter".  
⇒ The installed drivers appear.
4. Tap "ISO Printer".
5.  - Confirm.
6. Restart the terminal.

## 6.8 farmpilot



farmpilot is an Internet portal that is used to transmit task data from your desk to the machine terminals through the Internet.

### 6.8.1 Activating farmpilot

To activate farmpilot on your terminal, you must first activate its driver.

Please note that you can only activate the driver for farmpilot if the driver for ME ODI is deactivated.

### Procedure

1.  - Open the "Service" application.
2. Tap "Driver".
3. Tap "farmpilot".  
⇒ The installed drivers appear.
4. Tap "farmpilot".
5.  - Confirm.
6. Restart the terminal.

You must now enter the access data for the farmpilot portal.

### 6.8.2 Configuring the connection with farmpilot

Before you can connect the terminal to farmpilot, you must configure the connection.

You will receive this data when purchasing the farmpilot access data.

### Procedure

1.  - Open the "Service" application.
2. Tap "farmpilot".  
⇒ Configurable parameters appear.
3. Configure the connection.

**Parameter**

You will require the following parameters for the configuration:

**Server**

Server address

The server address cannot be altered.

**User name**

User name for farmpilot.

**Password**

Password for farmpilot.

**Modem**

Modem type:

- "Internal" – Installed in the terminal housing as standard.
- "External" – External modem, connected to the terminal.

**Provider**

Opens a screen where the GPRS connection can be configured.

With most mobile phone providers, this configuration occurs automatically.

If the access data for the GPRS connection differ with your provider, you can configure the connection manually.

**Diagnostics**

A number of parameters, which are used to diagnose faults. Customer service may ask for the values displayed here in the event of problems.

**6.9****Configuring the Bluetooth connection in the Connection Center**

If you connect a bluetooth stick to the terminal, you can couple the terminal with another bluetooth device (e.g. a smartphone).

This allows you to use the ME ODI (Müller Elektronik Open Data Interface) [→ 15] application.

**Procedure**

1. Connect the USB bluetooth stick to the terminal.



2. - Open the "Service" application.

3. Tap "Driver".

4. Activate the "Connection Center" driver (value: Connection Center)

5. Restart the terminal.



6. - Open the "Service" application.

7. Tap on "...".

8. Tap on "Connection Center".

⇒ The "Connection Center" screen appears.

9. Tap on "Bluetooth".



## 6.10

### Crop protection sensors

Crop protection sensors measure the plant requirements during operation. Depending on the sensor, the results are transmitted as a target rate to the job computer of the fertilizer spreader or sprayer.

The terminal can communicate with crop protection sensors through two interfaces:

- ISOBUS - If a sensor communicates via ISOBUS, it is automatically detected by the terminal. The target rates are transmitted directly to the job computer.
- Serial - If a sensor only communicates through the serial interface, you must connect it to the serial port on the terminal [→ 88]. Then you must create a virtual job computer for the sensor in the Virtual ECU [→ 68] app. Activate the virtual job computer before starting operation.

#### Procedure

To work with ISOBUS sensors:

1. Connect the sensor to the ISOBUS.
2. Follow the instructions from the sensor manufacturer. The terminal does not need to be configured.

#### Procedure

To work with serial connection sensors:

1. Connect the sensor to the serial port of the terminal.
  2. Create a virtual job computer in the Virtual ECU app. [→ 68]
  3. In the “External controller” [→ 69] parameter, select the sensor type.
  4. Activate the job computer for the sensor.
    - ⇒ You have activated the sensor.
- ⇒ The terminal transmits all target rates to ISOBUS-TC, the ISOBUS job computer and TRACK-Leader.

#### Special case

If you are working with your machine in mixed operation, with ISOBUS and serially connected sensors, you must observe the following sequence:

#### Procedure

- The serial sensor is connected to the serial interface of the terminal.
1. Connect the ISOBUS components to the ISOBUS.
  2. Start the Virtual ECU [→ 68] app.
  3. Create a virtual job computer in the Virtual ECU app. [→ 68]
  4. In the “External controller” [→ 69] parameter, select the sensor type.
  5. Activate the job computer for the sensor.
    - ⇒ You have activated the sensor.
  6. Set the connectors in the list of connections.
- ⇒ The terminal transmits all target rates to ISOBUS-TC, the ISOBUS job computer and TRACK-Leader.

## 7 Configuring the terminal in the Service application

### 7.1 Changing the language

If you change the language in the Service application, you also change the language for all applications and the ISOBUS job computer.

If a connected ISOBUS job computer cannot activate the selected language, a standard language will be activated.

#### Procedure

-  - Open the "Service" application.  
 ⇒ The application start screen appears:

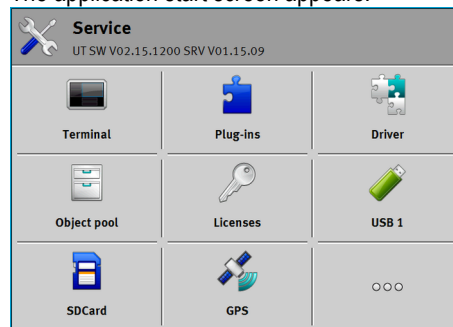

- Tap "Terminal".  
⇒ A list of parameters appears.
- Slide your finger over the terminal screen from the bottom to the top.  
⇒ New parameters appear.
- Tap "Language".  
⇒ A list of abbreviations of available languages appears.
- Tap the abbreviation for your language.  
⇒ The abbreviation is marked with a green dot.
-  - Confirm.  
 ⇒ The "Terminal" screen appears.
- Restart the terminal.

### 7.2 Changing the layout

The terminal is configured by default for working in landscape format. You can however change this after installation.

You can choose between the two following layouts:

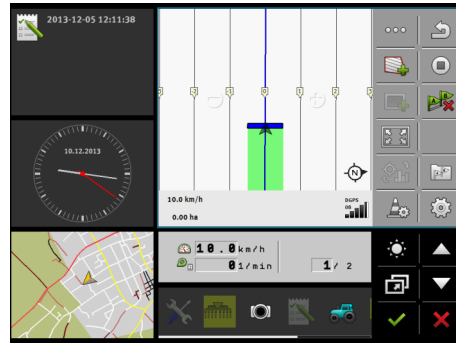

Landscape format

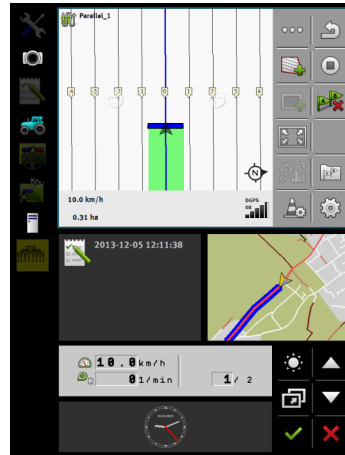

Portrait format

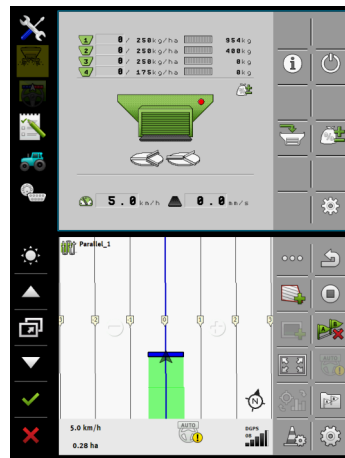

Duo-ISO

## Procedure

1.  - Open the "Service" application.  
⇒ The application start screen appears:

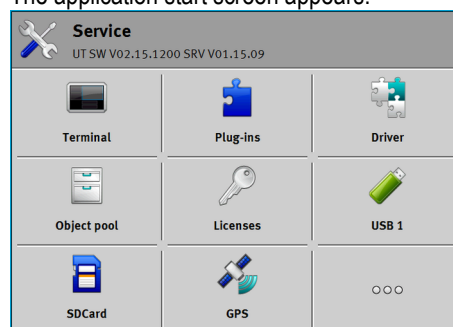

2. Tap "Terminal".

- ⇒ A list of parameters appears.
- 3. Slide your finger over the terminal screen from the bottom to the top.
  - ⇒ New parameters appear.
- 4. Tap "Layout".
  - ⇒ A list of the available layouts appears.
- 5. Tap on the desired layout.
  - ⇒ The layout is marked with a green dot.
- 6. - Confirm.
  - ⇒ The "Terminal" screen appears.
- 7. Restart the terminal.

## 7.3 Basic terminal settings

The basic settings include: Language, Time, Measurement units.

All settings which you make here will also apply to other applications and in connected ISOBUS job computers.

### Procedure

1. - Open the "Service" application.
  - ⇒ The application start screen appears:

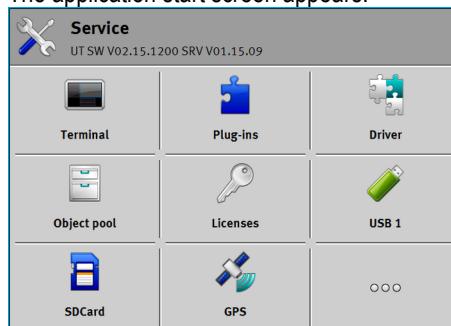

2. Tap "Terminal".
  - ⇒ A list of parameters appears. See the table below.
3. To change the value of any of the parameters, tap the desired parameter.
  - ⇒ A window appears, into which you can input the value of the parameter as a number, or select from a list.
4. - Confirm.
5. Restart the terminal.

### Parameters in the "Terminal" menu

Parameter name	Function
Brightness Day	Brightness of the terminal screen during the day.
Brightness Night	Brightness of the terminal screen at night.
Keyboard brightness	Lighting of the buttons.

Parameter name	Function
Volume	Volume of the terminal.
Date	Current date.
Time	Current time.
Time zone	Time difference in relation to GMT.
Language	Language of the applications on the terminal screen.
Measurement units	Measurement system.
Screenshot	When this parameter is activated, you can create screenshots on the terminal.
Layout	Layout of the terminal.
VT number	Parameters from the ISO standard Number that should be given to the terminal on the ISOBUS.
Login as ISOBUS-VT	Activate this parameter if you want the ISOBUS job computer to be displayed on the terminal. This parameter must be activated in most instances. On very few self-propelled agricultural machines, the parameter must be deactivated.
Number of navigation buttons	The terminal provides a maximum of 12 function icons in each application.  When you connect an ISOBUS job computer that has more functions in a single screen to the terminal, their function icons are spread over multiple pages. Furthermore, navigation buttons appear that can be used to scroll to the next page.  The number indicates how many buttons should be used to scroll between multiple pages with function icons.
Character representation	Character representation on the terminal.

## 7.4

### Activating and deactivating applications

In the "Service" application you can activate and deactivate other applications that are installed on the terminal.

The applications are installed in packages, in so-called plug ins. A plug in can contain several applications.

You can for example deactivate a plugin if you do not want to use it. The plug-in will then not be displayed in the selection menu.

Name of the plug-in	Activates the following applications
TRACK-Leader	TRACK-Leader

Name of the plug-in	Activates the following applications
	SECTION-Control TRACK-Leader TOP TRACK-Leader AUTO
ISOBUS-TC	Task management (ISOBUS-TC) [→ 73]
Tractor-ECU	Tractor-ECU application [→ 58]
Camera	The terminal screen will show the image from the connected camera.
FIELD-Nav	FIELD-Nav
FILE-Server	FILE-Server application [→ 85]
Virtual ECU	Virtual ECU application [→ 68]

**Procedure**

To activate and deactivate plug-ins:

1.  - Open the "Service" application.
2. Tap "Plug-ins".  
⇒ Screen "Plug-ins" appears.
3. To activate or disable a plug-in, tap it.  
⇒ A plug-in is activated when a checkmarker appears in front of its name.
4. Restart the terminal.

**7.5**

**Unlocking licenses for full versions**

Several applications are pre-installed on the terminal, which you can use for trial purposes for up to 50 hours. After this time has elapsed, they will be automatically deactivated.

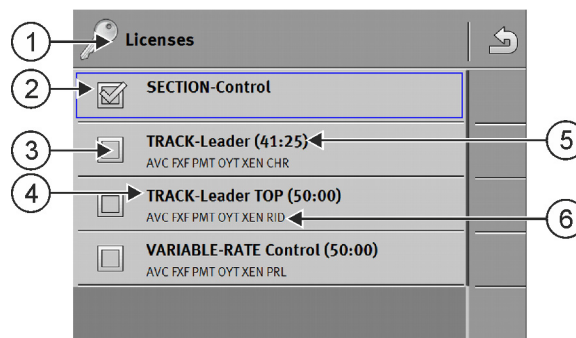

"Licenses" screen

①	Screen name	④	Name of the application
②	Unlocked applications are marked with check marks.	⑤	You can see how long you can still use a test version in the brackets: in hours and minutes.
③	Un-checked applications are locked.	⑥	18-digit alphabetical code of the application



You will need an activation key to unlock a license. To receive this, you will need to purchase a license from Müller-Elektronik.

If you request the activation key by phone or by email, you will be required to give our staff the following information:

- The name of the application for which you require a license.
- The 18-digit alphabetical code of the application. You will find this on the “Licenses” screen.
- Serial number of the terminal – Found on the nameplate on the reverse of the terminal.
- Item number of the terminal – Found on the nameplate on the back of the terminal.

## Procedure

To unlock a license:



1.  - Open the “Service” application.
2. Tap “Licenses”.
3. Order an activation key from Müller-Elektronik using the 18-digit alphabetical code.
4. Tap the name of the license that you want to unlock.  
⇒ The keyboard appears.
5. Enter the activation key.
6.  - Confirm.  
⇒ The “Licenses” screen appears.
7. Restart the terminal.  
⇒ The full version of the application is now unlocked.

## 7.6

### Creating screenshots

A screenshot is a photo of the screen being displayed.

## Procedure

1. Insert a USB memory device into the terminal.
2.  - Open the “Service” application.
3. Tap “Terminal”.
4. Set the “Screenshot” parameter to “Activated”.
5. To create a screenshot, press the  button.  
⇒ The content of the terminal screen will be saved as an image file on the USB memory device in the “Screencopy” folder.

## 7.7

### Deleting pools

Pools are the intermediate storage for the terminal. Pools are used to temporarily store graphics or text. Over time, the pools will become too large and slow down the operation of the terminal.

You can delete the pools to speed up the terminal's operation.

## When to delete?



Delete the pools:

- After updating the software of a connected job computer.
- If the terminal operates more slowly than usual.
- When asked to do so by Customer Services.

**Procedure**

To delete the pools:



1.  - Open the "Service" application.
2. Tap "Object pool".
  - ⇒ A list with the ISO names of ISOBUS job computers appears, whose graphics and text can be found in the storage of the terminal. You can determine from the icon which farm implement is being controlled by the job computer.
3. Tap the object pool which you want to delete.
4.  - Delete the object pool.
  - ⇒ Nothing happens if you delete the wrong object pool.
  - ⇒ The following message appears: "Do you want to delete the folder?"
5. To confirm, tap "Yes".
6. The current pool of the job computer will be loaded after the next restart.

**7.8****Using the Open Data Interface**

Müller-Elektronik Open Data Interface (short: ME ODI or ODI) is a driver that activates an interface to Internet services.

Through this interface, data can be exchanged between the terminal applications and external Internet-based services.

Examples: Transmitting tasks to the ISOBUS-TC, sending target rates to the job computer, etc.



**7.8.1****Activating ME ODI**

Please note that you can only activate the driver for ME ODI if the driver for farm pilot is deactivated.

**Procedure**

To activate ME ODI:



1.  - Open the "Service" application.
2. Tap "Driver".
3. Tap "Open Data Interface".
  - ⇒ The installed drivers appear.
4. Tap "ME ODI".
5.  - Confirm.
6. Restart the terminal.

**7.8.2****Opening ME ODI****Procedure**

To open ME ODI:



1.  - Open the "Service" application.
2. Tap on "...".



3. Tap "Open Data Interface".
  - ⇒ The "Settings" screen appears.

The overall configuration of the connection must take place through the online service. On the "Settings" screen, you can see information on the established connections:

- "Client" - Services that are presently connected to the terminal.
- "Diagnostics" - Here, you can record the connection sequence to be able to find the cause in case of an error.

## 8 Tractor-ECU application

The Tractor-ECU application is used to compile all of the information of the vehicle on which the terminal is mounted. Tractor-ECU can transfer this information to other apps (e.g. the position of the GPS receiver to TRACK-Leader or SECTION-Control) or to a connected ISOBUS job computer (GPS signal as a speed source).

The Tractor-ECU application allows you to:

- Create a profile for each vehicle, with specific settings.
- Input the sensors which are mounted on the vehicle.
- Enter the position of the GPS receiver.
- Define the GPS signal to determine the speed on the CAN bus.

### 8.1

#### Work screen

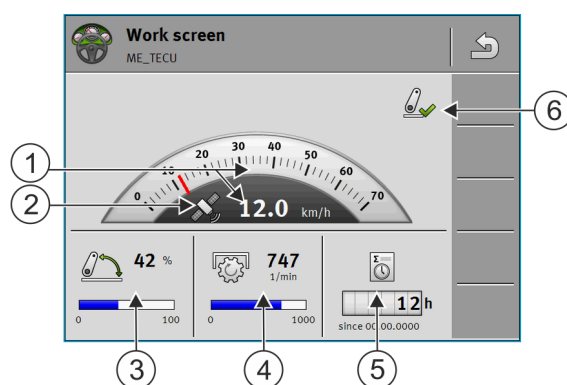

①	Speed display	④	PTO shaft speed
②	Speed Source	⑤	Number of operation hours
③	Position of the work position sensor	⑥	Status of the work position sensor

### 8.2

#### Managing the tractor profiles

Tractor profiles are used to store important features of the tractor on which the terminal is installed.

This offers the following advantages:

- You can use the terminal on several tractors. Each time you change tractors, you can activate the fitting tractor profile.
- Even if the terminal is always installed on one tractor, you can create several profiles for one tractor.

You can use between 1 and 31 tractor profiles.

The number of tractor profiles depends on several factors:

- Purpose of the terminal:
  - If you switch the mounted implement manually, or are using an implement for which cm-accuracy is not required, one tractor profile per tractor is enough.
  - If you are not using TRACK-Leader and SECTION-Control, you probably do not need tractor profiles.
- Required precision:

- If you are working with SECTION-Control and ISOBUS planters/seeder or field sprayers, the distance between the GPS receiver and the coupling is decisive. For this reason, you need one profile in which you measure the distance to the lower link in the geometry, and one profile in which you measure the distance to the drawbar.

- Number of tractors with different equipment and different geometries.

For self-propelled machines (e.g. field sprayers), you must use a tractor profile with the following settings:

- **“Connection with ISOBUS-TC?”** parameter - Ensure that this parameter is properly set.
- **“Speed”** parameter
  - GPS receiver - If a GPS receiver is connected to the terminal and is used to determine the speed.
  - Wheel sensor, radar sensor via CAN bus - If a speed sensor is connected to the junction box of the ISOBUS job computer, this setting allows you to use the speed display of the Tractor-ECU.
- **Geometry:** For self-propelled machines, the geometry is generally entered in the field sprayer job computer. For this reason, you do not need to enter any distances in the Tractor-ECU.

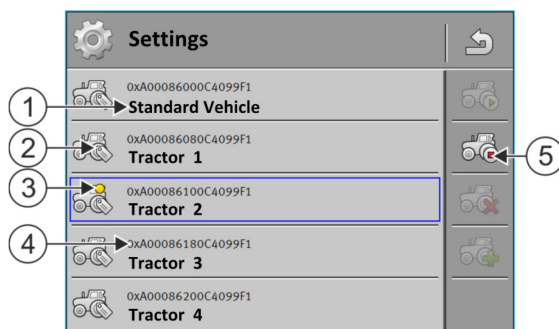

①	Name of a tractor profile	④	ISO name of the tractor profile (The numbers in the middle differ among the profiles)
②	Icon for the tractor	⑤	Function icons. If at least one tractor profile is activated, only the stop icon appears.
③	State of the tractor profile: <b>Green</b> = Profile is activated; <b>Yellow</b> = Profile will be activated after restarting the terminal.		

Function icon	Function
	Creates a new tractor profile.
	Activates the marked tractor profile.
	Deactivates the tractor profile.
	Calls up the parameters stored in the tractor profile.

Function icon	Function
	Deletes the tractor profile.



### Procedure

1.  - Open the Tractor ECU application.
2. Tap "Settings".
  - ⇒ The existing tractor profiles appear.
  - ⇒ If a tractor profile is activated, most of the other function icons are greyed-out.
3. A maximum of five tractor profiles can be displayed on one page. To view other profiles, swipe across the screen with your finger from bottom to top.
4. To edit a tractor profile or to create a new one, you must deactivate the activated tractor profile.

## 8.3

### Parameter

#### Procedure

1.  - Open the Tractor ECU application.
2. Tap "Settings".
  - ⇒ The existing tractor profiles appear.
3.  - If a tractor profile is activated, deactivate it.
4. Tap on the profile to be configured.
  - ⇒ The profile will be marked.
5.  - Call up the parameters for the marked tractor profile.
  - ⇒ The parameters are displayed.

#### Name

Name of the tractor profile.

#### Connection with ISOBUS-TC?

With this parameter, you can set whether the Tractor ECU application should communicate with the ISOBUS-TC application. In doing so, it transmits: Counters, work position, position of the GPS receiver.

Deactivate this parameter only if the terminal is used as a secondary terminal and the GPS receiver is connected to a different terminal.

#### Speed

Configuring the speed sensor. This measures the speed.

Possible values:

- "deactivated"  
No sensor measures the speed.
- "Wheel sensor"

- A wheel sensor is connected to the terminal. The wheel sensor must be calibrated [→ 62].
- “Radar sensor”  
A radar sensor is connected to the terminal. The radar sensor must be calibrated [→ 62].
- “GPS receiver”  
The speed is calculated using GPS.
- “Unknown sensor via CAN”  
A wheel sensor or a radar sensor is connected to the terminal via CAN.
- “Radar sensor via CAN”  
A radar sensor is connected to the terminal via CAN.
- “Wheel sensor via CAN”  
A wheel sensor is connected to the terminal via CAN.

### Pulses per 100 m

This parameter is only required if you have selected one of the following speed sources: Wheel sensor or radar sensor. In other cases, any value entered here will be ignored.

The speed sensor calibration results appear under this parameter.

### Work position sensor

With this parameter, you can set whether there is a work position sensor and how its signal reaches the terminal.

There are three parameters that can be used to configure the work position sensor:

#### “Mounting position and connection” parameter

Possible values:

- “deactivated”  
No sensor measuring the work position.
- “Front via connector B”  
A work position sensor, is located on the front hitch or on the implement mounted on the front hitch. It is connected to the terminal via connector B. The work position sensor must be configured.
- “Rear via connector B”  
A work position sensor, is located on the rear hitch or on the implement mounted on the front hitch. It is connected to the terminal via connector B. The work position sensor must be configured.
- “Unknown sensor via CAN”  
There is a work position sensor determining the work position of the implement. It is connected to an ISOBUS job computer or to a different terminal. The signal reaches the terminal via CAN.
- “Front via CAN”  
There is a work position sensor determining the work position of the implement at the front of the vehicle. It is connected to an ISOBUS job computer or to a different terminal. The signal reaches the terminal via CAN.
- “Rear via CAN”  
There is a work position sensor determining the work position of the implement at the rear of the vehicle. It is connected to an ISOBUS job computer or to a different terminal. The signal reaches the terminal via CAN.
- “TRACK-Leader AUTO”  
As soon as the steering system is activated, the system assumes that the implement is in work position.

### “Sensor Type” parameter

If a work position sensor is connected to the terminal via connector B, you must tell the terminal the principle according to which the sensor functions.

Possible values:

- “analog”  
You are using an analog work position sensor [→ 63], which measures the height of the hitch linkage as a percentage.
- “digital”  
You are using a digital, ISO-compatible work position sensor in accordance with ISO 11786. The sensor is connected to the terminal via the signal socket.
- “ME-sensor Y”  
You are using a work position sensor provided by Müller-Elektronik. The sensor is connected to the terminal.

### “Inversion” parameter

As a standard, the terminal assumes that the implement is in work position as soon as the work position sensor sends a signal. However, if the work position sensor functions inversely, you have to set it here.

Possible values:

- “Yes” - implement is in work position when the sensor is not occupied.
- “No” - implement is in work position when the sensor is detecting something.

### PTO shaft speed

Configuring the PTO (power take-off) rotational speed sensor. It measures the rotational speed of the PTO.

Possible values:

- “deactivated”  
No sensor measures the rotational speed of the PTO.
- “Revol. sensor - front”  
A rotational speed sensor that is fitted onto the front PTO.
- “Revol. sensor - rear”  
A rotational speed sensor that is fitted onto the rear PTO.

### Impulses per revolution

Number of impulses per revolution that are transmitted by the PTO through the selected PTO sensor.

## 8.3.1

### Calibrating the speed sensor



When calibrating the speed sensor using the 328.085ft (100m) method, determine the number of targets which the speed sensor encounters over a distance of 328.085ft (100m).

If you know the number of targets for the speed sensor, you can also input this manually.

#### Procedure

- You have measured and marked a distance of 100m. The distance must correspond to the field conditions. You must therefore drive across a meadow or a field.
- The vehicle with the connected implement is operational for a 100m drive and is at the start of the marked distance.
- You have connected a wheel sensor or radar sensor to the terminal.

- You have selected the value "Wheel sensor" or "Radar sensor" in the "Speed" parameter.

1.  - Open the Tractor ECU application.
  2. Tap "Settings".
  3. Mark the vehicle for which you want to calibrate the speed sensor.
  4. Tap .
  5. Tap .
  6. Follow the instructions on the display screen.
- ⇒ You have calibrated the speed sensor.



### 8.3.2

#### Calibrating an analog work position sensor

If you have connected an analog work position sensor to the terminal, you have to show the terminal the position as of which the implement is in work position.

#### Procedure

- You have connected a work position sensor directly to the terminal or via the signal socket to the terminal.
- You have selected the analogue sensor in the "Sensor type" parameter.

1.  - Open the Tractor ECU application.
  2. Tap "Settings".
  3. Mark the vehicle for which you want to calibrate the analog work position sensor.
  4. Tap .
  5. Move the implement into work position.
  6. Tap  to teach-in the work position on the terminal.
  7. Confirm.
- ⇒ You have configured the work position sensor.

### 8.3.3

#### Tractor geometry

The tractor geometry represents a series of dimensions on the vehicle.

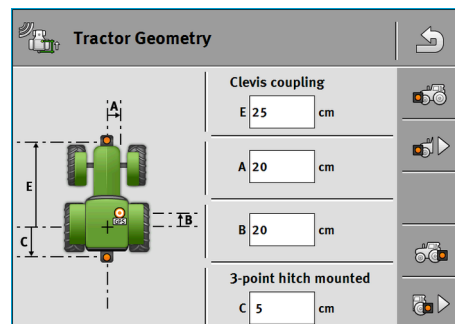

Examples of tractor geometry

<b>A</b>	Distance between the centre of the vehicle and the GPS receiver, on the left-right axis. If the receiver is installed on the left side, enter a negative value. Users of <b>TRACK-Leader AUTO®</b> : The position of the GPS receiver must also be entered and calibrated in the steering job computer. For this reason, the <b>A</b> and <b>B</b> boxes are greyed-out and cannot be edited.
<b>B</b>	Distance between the GPS receiver and the rear axle of the vehicle.
<b>C</b>	Distance between the rear axle and the rear mounting or attachment point.
<b>E</b>	Distance between the rear axle and the front mounting or attachment point.



### Configuring the tractor connector types

The connector type can differ among various tractors and mounted or trailed implements. Per default, the connector type is always set to "Unknown".



Please note that when you select a different connector type or multiple different connector types, the automatic list of connections no longer works. You then have to list the connections manually.

The following connector types are possible:









- Unknown
- Drawbar
- 3-point hitch mounted
- 3-point hitch semi-mounted
- Hitch hook
- Clevis coupling
- Piton-type coupling
- CUNA hitch
- Ball-type hitch

Function icon	Meaning
	Adds a new connector type.
	Deletes the marked connector type.
	Edits the marked connector type.

### Procedure







1.  - Open the Tractor ECU application.
2. Tap "Settings".
  - ⇒ The existing tractor profiles appear.
  - ⇒ If a tractor profile is activated, most of the other function icons are greyed-out.
3.  - To edit a tractor profile or to create a new one, you must deactivate the activated tractor profile.
4. Tap on the tractor profile to be edited.
5.  - Call up the parameter list.
  - ⇒ The parameters are displayed.



6.  - Open the tractor geometry screen.
7.  - Call up the screen for configuring the front connector types.  
⇒ The “Front - connector type” screen appears.
8.  - Add a connector.
9. Select the connector type.
10. Enter the distance between the rear axle and the front mounting or attachment point.
11.  - Confirm.
12. Optionally, you can  edit or  delete other connector types.
13.  - Repeat this procedure for the rear connector types. Enter the distance between the rear axle and the rear mounting or attachment point.
14.  - Terminate the entry.  
⇒ The tractor geometry can now be viewed and edited. [→ 65]

### Configuring the tractor geometry

#### Procedure

- You have configured the connector types of the tractor. [→ 64]
1.  - Open the Tractor ECU application.
  2. Tap “Settings”.  
⇒ The existing tractor profiles appear.  
⇒ If a tractor profile is activated, most of the other function icons are greyed-out.
  3.  - To edit a tractor profile or to create a new one, you must deactivate the activated tractor profile.
  4. Tap on the tractor profile to be edited.
  5.  - Call up the parameter list.  
⇒ The parameters are displayed.
  6.  - Open the tractor geometry screen.
  7.  /  - Select the currently used connector type. Per default, the connector type is always set to “Unknown”. Please note that when you select a different connector type or multiple different connector types, the automatic list of connections no longer works. You then have to list the connections manually.
  8. Adopt the pre-set distances for the connector types or enter new distances as shown in the figure above.

## 8.4 Results

The Tractor ECU application documents the work in two counter groups:

- Trip counter
- Task-related counter



### 8.4.1 Trip counter

Counter designation	This is documented
Applied distance	Distance during which the work position sensor was activated.
Applied area	Area during which the work position sensor was activated. The Tractor ECU application uses the set working width as a basis for the calculation of the area.
Working time	Time during which the work position sensor was activated.

#### Procedure

To clear a trip counter:

1.  - Open the Tractor ECU application.
2. Tap "Results".  
⇒ The "Results" screen appears with the trip counters.
3. Tap the function icons to clear the trip counters.

Icon	This counter will be erased
	Applied distance
	Working time
	All trip counters

### 8.4.2 Task-related counter

These counters are transmitted to the ISOBUS-TC app. You can activate the counters in a task, and they will then appear in the additional window as soon as the ISOBUS-TC App is minimized.

#### Task-related counter

Counter designation	Unit	This is documented
Distance	km	Distance during which the work position sensor was activated.
Time in work position	h	Time during which the work position sensor was activated.

Counter designation	Unit	This is documented
Work position	0/1	0 = not in work position 1 = in work position

## 9 Virtual ECU application

The Virtual ECU application (or VECU for short) is used to create virtual job computers for the following implements:

- Implements that do not have their own job computer. For example: Cultivators, ploughs, mechanical seeders, etc.
- Machines that are operated using an on-board integrated display/controller connected to the serial interface.
- Crop protection sensors that are connected serially to the terminal.



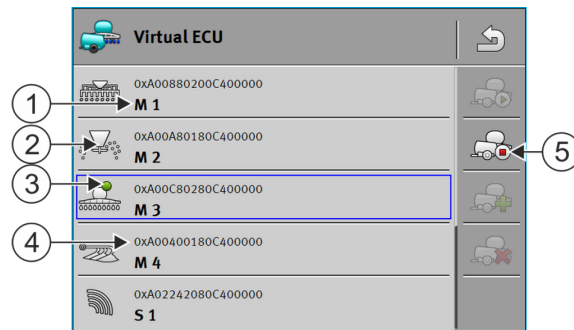

Each virtual job computer contains the most important features of the respective machine (working width, geometry, type of on-board integrated display/controller) and provides these to other applications if required.

### 9.1

### Managing virtual job computers



①	Name of the virtual job computer	④	ISO name of the virtual job computer
②	Implement type	⑤	Function icons. If at least one virtual job computer is activated, only the stop icon appears.
③	State of the virtual job computer: <b>Green</b> = Profile is activated; <b>Yellow</b> = Profile will be activated after restarting the terminal.		

Function icon	Function
	Creates a new job computer.
	Activates the marked job computer.
	Deactivates the job computer.
	Calls up the parameters stored in the virtual job computer.
	Deletes the job computer.

#### Procedure

1.  - Open the "Virtual ECU" app.

2. Tap "Settings".
  - ⇒ The existing virtual job computers appear.
  - ⇒ If a job computer is activated, most of the other function icons are greyed-out.
3. A maximum of five job computer profiles can be displayed on one page. To view other profiles, swipe across the screen with your finger from bottom to top.
4. To edit a job computer profile or to create a new one, you must deactivate the activated job computer profile.

## 9.2

### Parameter

#### Name

Name of the virtual job computer.

#### External Controller

If you have connected an on-board integrated display/controller or crop protection sensor to the serial interface, you must select the model in this parameter.

The list contains the following devices:

- On-board integrated display/controllers that can communicate using one of the protocols ASD or LH5000 and are capable of communicating with the terminal. If you want to connect an on-board integrated display/controller that supports this protocol, but does not appear in the list, please contact Müller-Elektronik and perform the steps shown at the end of this section.
- Crop protection sensors that can be connected to the serial interface of the terminal.
- AMABUS. Please note that to connect the AMABUS, you need a special cable, item number: 30322572

#### Procedure

This is how you update the list of on-board integrated display/controllers:

- You have contacted Müller-Elektronik and received a USB memory device with the installation file.
  - The Virtual ECU application is closed.
1. Insert the USB memory device into the terminal.
  2. Start the Virtual ECU application.
    - ⇒ The following message appears: Do you want to update the list of external on-board integrated display/controllers?
  3. Select "Yes" to update the list.
  4. Confirm.
  5. Restart the terminal.
    - ⇒ You can now also select the added on-board integrated display/controller.

#### Implement type

Use this parameter to define the type of implement.

The following implement types are available:

- Seeder
- Fertilizer spreader

- Sprayer
- Soil tillage

### Connector type

Use this parameter to define the connector type of the agricultural implement.

The following connector types are possible:

- Unknown
- Drawbar
- 3-point hitch mounted
- 3-point hitch semi-mounted
- Hitch hook
- Clevis coupling
- Piton-type coupling
- CUNA hitch
- Ball-type hitch

### Machine model

This parameter influences how the working bar follows the arrow in TRACK-Leader. The configuration improves the precision of the recording of applied areas in curves.

After each change, you also need to adjust the geometry.

Possible values:

- "mounted"  
Setting for implements that are mounted on the tractor three-point hitch.
- "trailed"  
Settings for implements trailed by a tractor. The working bar is guided like a trailer behind a tractor.

### Working width

This parameter shows the working width set for an implement.

### Number of sections

Enter the number of sections that can be switched off on the implement. On a field sprayer, they are the section valves; on a fertilizer spreader or a planter/seeder, they can be e.g. metering units.

This parameter serves to transmit the proper number of sections to the SECTION-View module, so that you can switch the sections manually.

Each section appears as part of the working bar on the screen.



### Sections

Opens a screen where you can enter the width of the individual sections on the implement.

### Geometry

The geometry contains a series of dimensions that help to properly display the vehicle-implement combination in TRACK-Leader and determine its position.

To call up the geometry, tap the function icon:

 	<p>Calls up the machine geometry.</p>
--	---------------------------------------

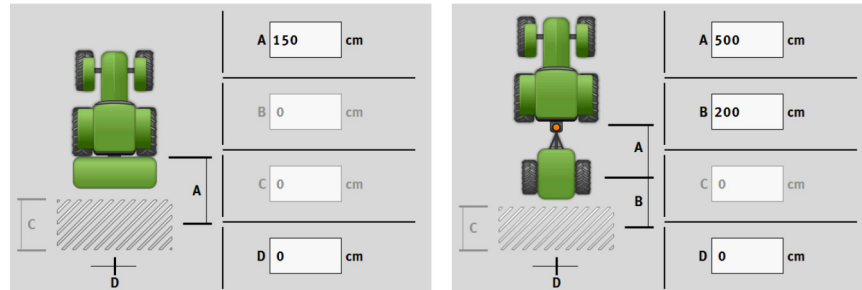

Screen for entering the geometry for different machine models

<b>A</b>	<p><b>Mounted:</b> Distance between the coupling point and the work point of the machine.</p> <p><b>Trailed:</b> Distance between the coupling point and the pivot point of the machine. For single-axle trailers, the pivot point is located at the centre of the axle, for tandem trailers between two axles. For planters/seeder, cultivators and other soil tillage implements, the pivot point must be determined individually.</p>
<b>B</b>	<p><b>Mounted:</b> Not available</p> <p><b>Trailed:</b> Distance between the pivot point of the machine and the work point.</p>
<b>C</b>	Only for spreaders: Working Length
<b>D</b>	<p>Lateral offset If the mounted implement is offset to the left in the direction of travel, enter a negative value. For example: - 50 cm.</p>

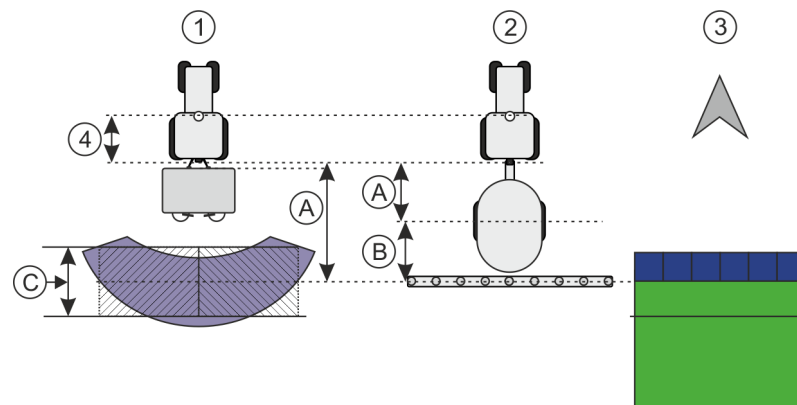

Geometry of machines and display in TRACK-Leader

①	Mounted fertilizer spreader
②	Trailed sprayer
③	Display in TRACK-Leader

### TRAMLIN-View

TRAMLIN-View contains parameters that are used to correctly display tramlines in TRACK-Leader when using seeders.

To use TRAMLIN-View, the “TRAMLIN-Management” license must be activated.

To call up TRAMLIN-View, tap the function icon:

	Calls up TRAMLIN-View.
---	------------------------

Parameter:

- “Tramline rhythm”  
Defines the tramline rhythm to be used for operation.
- “Working Start”  
Defines the point on the field at which you want to start working.
- “Begin with half the working width”  
Defines whether you make the first field track after starting to work with only half of the working width.

## 9.3

### Work screen

The following information may appear on the work screen:

- Serially transmitted application/spread rates: Target rates and current rates
- Section status and number
- Implement geometry



## 10 Task management (ISOBUS-TC)

The ISOBUS-TC application has two jobs:

- As **Task Controller**, the application controls all of the relevant data between the terminal and other implements that are connected to the ISOBUS or terminal (Part 11 of the standard ISO11783).
- As **Task Manager**, the application enables the creation and editing of ISO-XML tasks. This also enables communication with Farm Management Information Systems (Part 10 of the standard ISO11783).

The jobs performed by the application depend on how the “Operating Mode” parameter is configured.

- **“Standard”** - Only the Task-Controller jobs
- **“Extended”** - Task-Controller and Task-Manager jobs

### 10.1 Configuring ISOBUS-TC

#### 10.1.1 The “farmpilot” parameter

This parameter shows the status of the connection to the “farmpilot” portal.

#### 10.1.2 “Operating Mode” parameter

With this parameter, you can set whether the Task Controller of ISOBUS-TC should work in the background or if you want to work actively with ISO-XML tasks.

- **“Standard”** - Two working methods are possible here.

Working method 1:

- All task data is managed through the “TRACK-Leader” app.
- In ISOBUS-TC, you cannot create any tasks.
- In this operating mode, ISOBUS-TC works in the background.

Working method 2:

- You can load field data from a shape file (field boundaries, guidance lines) in ISOBUS-TC. This field data is made available in the “TRACK-Leader” app. Also possible without an ISOBUS-TC license.
- After activating the ISOBUS-TC license, you can edit shape prescription maps.
- In ISOBUS-TC, you cannot create any tasks.

- **“Extended”** - In this operating mode, the ISOBUS-TC menu is extended. The ISOBUS-TC license is required. In this mode, ISOBUS-TC serves to manage and process ISO-XML tasks. Two working methods are possible here.

Working method 1:



- You can manage and process ISO-XML tasks using a Farm Management Information System.

Working method 2:

- You can create and manage master data yourself in the ISOBUS-TC app.

In these instructions, only the standard mode will be explained. The extended mode is described in the separate instructions for ISOBUS-TC.

## Procedure

-  - Open the ISOBUS-TC application.
- Tap “Settings”.
- Tap “Operating Mode”.
- Tap “Extended” if you want to work with tasks. Tap “Standard” to be able to work without tasks.
-  - Confirm.  
⇒ You will be asked whether you want to change the setting.
- Tap “Yes” if you want to confirm this.  
⇒ All data will be saved and the operating mode will be switched.
- Wait until all messages have faded out.

### What happens with the data?

The data structure is different in the two operating modes. After changing the mode, the task and field data will be saved. When switching again, the stored data will be loaded.

#### 10.1.3

##### “TC number” parameter

Number of the Task-Controller. For complex systems with multiple terminals and Task-Controllers, several Task-Controllers can be distinguished based on this number. If need be, you can control which Task-Controller the connected job computer should communicate with.

#### 10.1.4

##### “Prefer internal Tractor-ECU?” parameter

This parameter is important on vehicles that have their own Tractor-ECU in addition to the ME terminal.

Activate the parameter if the GPS receiver is connected to the ME terminal or to the TRACK-Leader AUTO steering system. Deactivate the parameter if the GPS receiver is connected to a different terminal.

#### 10.1.5

##### “Save finished tasks as a file?” parameter

If this parameter is activated, all ISO-XML tasks are saved on the memory device as a text file.

#### 10.1.6

##### “Validation of the device description” parameter

Optional parameter. Deactivated per default.

Please note that when the parameter is activated, Task-Controller version 3 is supported. If the parameter is deactivated, Task-Controller version 2 is supported.

Only activate this parameter if you want to ensure that SECTION-Control and ISOBUS-TC only communicate with AEF-compliant job computers.

Job computers that are not AEF-compliant are not supported by ISOBUS-TC in this case.

### 10.1.7 “Simplified target rate assignment?” parameter

Optional parameter. Set to “No” per default.

When you activate this parameter, the target rate settings from the previous task can be adopted for a new task. To do so, you must set the parameter to “Yes”.

When you then create a new task, the following message appears:

“Should be target rate settings for the implement be adopted from the previous task?”

Confirm this message to adopt the target rate settings.

## 10.2 Configuring the list of connections

The list of connections indicates the ISOBUS job computers from which the terminal will load the geometries of the connected implements. This geometry is required in order to calculate the position of all implement components on the basis of the GPS signal. Only in this way are precise parallel guidance and section control possible.

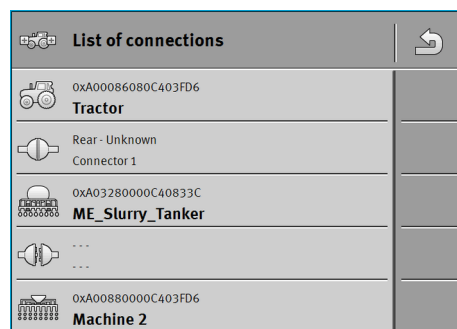

①	Icon for the tractor	④	ISO name of the tractor
②	Connection between the tractor and the job computer is established  - Connected implements	⑤	Name of the job computer
③	Icon for the ISOBUS job computer	⑥	Not all of the equipment in the list must be connected.  - Disconnected implements

In simple systems, the terminal can set up the list of connections automatically. In particular, when the ME terminal is the only unit containing the tractor geometry.

It can however still be necessary to set the list of connections manually in the following instances:



- If a tractor job computer (Tractor-ECU), in which the tractor geometry is saved, is mounted as an independent job computer on the tractor. In this instance, you must decide which Tractor-ECU is connected in the list of connections with other equipment: the application on the ME terminal or on the tractor job computer.
- If the system cannot organize the ISOBUS job computer by itself. For example when more than one implement is connected to the tractor (e.g.: slurry tanker and planter/seedler).
- When the connection to an ISOBUS job computer is interrupted during the start-up of a ISO-XML task. In most cases, the list of connections will be set correctly as soon as you reconnect the ISOBUS job computer.
- If this error message appears when starting the terminal: “List of connections is incomplete.”

- When the following error message appears when starting a navigation in TRACK-Leader: “The device data is still loading.” The settings in the list of connections can eliminate this problem.

### Procedure

If you are using the ISOBUS-TC application in “Standard” mode, you can configure the list of connections as follows:

- All ISOBUS job computers and virtual job computers that are required for a field are connected.





1.  - Open the ISOBUS-TC application.
2. Tap “Farm equipment”.
  - ⇒ The “Farm equipment” screen appears.
3.  - Open the list of connections.
  - ⇒ You have called up the list of connections screen.
  - ⇒ A list appears with all of job computers, controllers and ECUs connected to the ISOBUS. The connectors appear between these devices.
4. Tap the task in the top row in order to select the first implement.
5. The device that is connected to the ME terminal should appear in the second line. Tap the line with the second implement and select one from this.
6. You now only need to select the appropriate connector between the two devices. Tap the line between the devices and select the appropriate connector for each device.
7.  - Exit the screen to save the settings.









## 10.3

### Using fields and shp data

In the “Fields” category, you can create all of the fields that you want to process. For each field, you can enter the following properties:

- Field name
- Code
- Area
- Field boundary
- Guidance lines
- Guidance Line Set
- Obstacle
- Prescription map (ISOBUS-TC license required)

Icon	Function
	Creates a new field.
	Activates the field.
	Deactivates the field.
	Enables editing of the field properties.

Icon	Function
	Deletes the field. Icon only appears when you tap 
	Enables the import of field data.
	Displays the loaded prescription map.
	Displays the imported field data.
	Enables the export of field data. Icon only appears when you tap 
	Deletes the selected data. Icon only appears when you tap 

### 10.3.1

#### What is field data for?

##### Purpose



All field properties that are stored in this way can be used when working in TRACK-Leader. To do so, you must activate the field to be processed in ISOBUS-TC before each navigation.

### 10.3.2

#### Creating fields

##### Procedure

To create a new field:

1.  - Open the ISOBUS-TC application.
2. Tap "Fields".
  - ⇒ A list with already created fields appears. You can store various field data for each field. For example: Field name, area, field boundary, prescription map and obstacles. You can access this data when you work on the same field in the future.
3.  - Create a new field.
  - ⇒ A form for entering the data appears.
4. On the topmost line, enter a field name.
5.  - Exit the screen.
  - ⇒ You will be asked whether you want to save the changes.
6. Confirm.
  - ⇒ A list of created fields appears. The new field appears at the bottom end. Each field is given a clear PFD number. The fields are sorted according to these numbers. The numbers can be seen in the field list above the respective field name. Moreover, you can see the number in the header when you open the field.

### PFD numbers

Each PFD number is only given one single time. Even if you delete a field, its PFD will not be used again.

When processing the fields in TRACK-Leader, this number will also be assigned when saving the field data in the ngstore database and attached to the field name.

Example:

Work performed on field PFD1 will be saved in TRACK-Leader under "ISOBUS-TC--1".

Work performed on field PFD50 will be saved in TRACK-Leader under "ISOBUS-TC--50".

## 10.3.3

### Activating and deactivating fields

#### Procedure

You can activate a field as follows:

- In the "Virtual ECU" application, you have activated the virtual job computer for the implement to be used or you have connected an ISOBUS job computer.

- Operating mode of ISOBUS-TC: Standard



1. - Open the ISOBUS-TC application.

2. Tap "Fields".

⇒ A list with already created fields appears.

3. Tap the entry with the field to be processed.



4. - Activate the field.



5. - Open the TRACK-Leader application.

6. Start a new navigation.

⇒ The terminal loads all of the data from the storage: Field boundaries, guidance lines, tracks.

⇒ In doing so, the terminal also takes account of which job computer was used to process the field. Therefore, if you work on the field two consecutive times with the field sprayer, the tracks for the field sprayer will be loaded the second time. However, if you work on the field with a fertilizer spreader, the tracks for the fertilizer spreader will be loaded.

7. Depending on which machine you are working with, you can create or select a suitable guidance line set in TRACK-Leader. More information on guidance line sets can be found in the instructions for TRACK-Leader.

If you want to rework the field, you must go to the "Storage" menu in TRACK-Leader and delete the

tracks there with .

#### Procedure



To finish the work:

- The navigation screen is called up in TRACK-Leader.

- You have worked the field in TRACK-Leader. On the screen, you can see the field with field boundary, guidance lines and other field data.



1. - Terminate the navigation in TRACK-Leader.



2.  - Open the ISOBUS-TC application.
3. Tap "Fields".
4. Tap the entry with the field that was just processed.
5.  - Deactivate the field.
  - ⇒ The field will be deactivated. In the process, it will also be saved with all of the current field data. With the next activation, the data will be automatically loaded again.

### 10.3.4

#### Importing field data (\*.shp)

##### Procedure

To import field data:

- The shp files are in WGS84 format.
1. Copy the field data to be imported to the **SHP** folder on the USB memory device.
  2. Please insert the USB memory device.
  3.  - Open the ISOBUS-TC application.
  4. Tap "Fields".
  5. If you have not created a field yet, create a field. [→ 77]
  6. Tap the field for which you want to load the shp data.
    - ⇒ The field properties appear. You can see the previously entered data and several function icons on the side.
  7.  - Open the import view.
  8. Tap "Data type".
    - ⇒ A list with possible data types appears.
  9. Select the type of field data that you want to load.
  10. Tap "File selection".
  11. Select the file.
    - ⇒ A preview of the imported data appears.
  12.  - Exit the screen.
    - ⇒ The message "Do you want to import the selected file?" appears.
  13. "Yes" - to confirm.
  14. Repeat the import procedure for additional field data.
    - ⇒ The preview of the imported data will be supplemented each time.
- ⇒ All of the desired field data will be loaded.

If you now activate the field, you can start a new navigation with the loaded field data.





### 10.3.5

#### Exporting field data

##### Procedure

To export field data:

1. Please insert the USB memory device.

2.  - Open the ISOBUS-TC application.
3. Tap "Fields".
  - ⇒ A list with already created fields appears.
4. Tap the field for which you want to export data.
  - ⇒ The field properties appear. You can see the previously entered data and several function icons on the side.
5.  - Open the field view.
6.  - Open the list with all field data.
7.  - Export the field data.

### 10.3.6

#### Data on the memory device

During work with TRACK-Leader, two types of data are produced:

- Tracks - Everything that is marked in green on the screen. This data describes one single work process.
  - The tracks are automatically saved in TRACK-Leader as soon as the field is deactivated in ISOBUS-TC.
  - You are in the "ngstore" folder on the USB memory device.
  - They could be imported for evaluation with TRACK-Guide Desktop.
  - Each field is given the name **ISOBUS-TC--PFD**. Whereby PFD stands for the PFD number of the field in ISOBUS-TC. For example: ISOBUS-TC--2
- Changing of fixed field data: Field boundaries, guidance lines, obstacles. This data is not only important for one work process, it can also be used in the future.
  - This data is saved as shp files in the "SHP" folder.

### 10.3.7

#### Transferring field data to a different terminal

##### Procedure

To transfer all field data to a different terminal:

- Operating mode of ISOBUS-TC: Standard
- 1. Terminal 1: Export all field data to a USB memory device. [→ 79]
- 2. Terminal 2: Create the field profiles once again. [→ 77]
- 3. Terminal 2: Import all field boundaries, guidance lines etc. from a USB memory device. [→ 79]

## 10.4

### Using prescription maps

Prescription maps are maps that contain information on the quantity of a product (fertilizer, seed, pesticide) to be spread/applied on each area of the field.

When the prescription map has been loaded, the terminal checks via GPS coordinates of the vehicle what application rates are needed according to the prescription map and transfers this information to the appropriate ISOBUS job computer.



The terminal can open prescription maps in two formats:

- Shape format (\*.shp)
  - The ISOBUS-TC app is used to open a prescription map in shape format.
  - Multiple prescription maps can be imported.
  - Only one prescription map can be used at a time. If you want to use more than one prescription map, you need a license for MULTI-Control. This way, for implements that have more than one metering unit, you can use a prescription map for each metering unit. The procedure is described in the MULTI-Control II instructions.
- ISO-XML format
  - The prescription map must be added to an ISO-XML task on a PC.
  - The prescription map can only be used in combination with an ISO-XML task through the ISOBUS-TC application.
  - The format is supported by all ISOBUS job computers, regardless of their manufacturer.
  - Several prescription maps can be used simultaneously in one task. This way, for implements that have more than one metering unit, you can use a prescription map for each metering unit. To do so, you need the MULTI-Control license. The procedure is described in the MULTI-Control II instructions.



## 10.4.1

### Importing shape prescription maps

You can import more than one prescription map for a field.

#### Procedure

To import a prescription map:

- The ISOBUS-TC license must be activated.
- 1. Copy a shape prescription maps to the “**SHP**” folder on the USB memory device.
- 2. Please insert the USB memory device.
- 3.  - Open the ISOBUS-TC application.
- 4. Tap “Fields”.
- 5. If you have not created a field yet, create a field. [→ 77]
- 6. Tap the field for which you want to load the prescription map.
  - ⇒ The field properties appear. You can see the previously entered data and several function icons on the side.
  - ⇒ If a prescription map has already been activated for this field, its name appears on the “Prescription map” line. You can still import another one.
- 7.  - Open the import view.
- 8. Tap “Data type”.
  - ⇒ A list with possible data types appears.
- 9. Select “Prescription map”.
- 10. Tap “File selection”.
- 11. Select the prescription map.
  - ⇒ The screen with the properties of the prescription map appears.

12. When a prescription map is imported for the first time, first tap “Column selection” to choose the column with the target rates, then tap “Unit selection” to choose the units. For future imports, these values will be automatically selected.

13.  - Exit the screen.

14. The overview image of the prescription map appears.

15.  - Exit the screen.

16. You will be asked whether you want to import the file.

17. Confirm.

18. The prescription map has been loaded and stored in the field data.

## 10.4.2

### Selecting shape prescription maps

You can import a multitude of prescription maps for each field. Before starting operation, you must activate the right prescription map.

If only one prescription map was imported, it will be automatically activated when starting up. Depending on which work mode you are using, the prescription map is activated either when starting a field (in “Standard” mode) or when starting a task (in “Extended” mode).

#### Procedure

To activate a prescription map:

You have imported several prescription maps.

1.  - Open the ISOBUS-TC application.
2. Tap “Fields”.
3. Tap the field that you want to work on.
  - ⇒ The field properties appear.
  - ⇒ If a prescription map has already been activated for this field, its name appears on the “Prescription map” line.
4. Tap “Prescription map”.
5. Select a prescription map.
  - ⇒ When you activate the field, this prescription map will be used.

## 10.4.3

### Editing shape prescription maps





After importing the prescription map, you can:

- Change all values by a certain percentage point.
- Change selected values by an absolute number.

#### Procedure





To change all of the values at once:

1.  - Open the ISOBUS-TC application.
2. Tap “Fields”.
3. Tap on the field to be edited.

4. Tap .
5. Tap .
6. Enter the desired change in value. For example: 50% = halve, 200% = double
7.  - Confirm.
  - ⇒ The "Prescription maps" screen appears.
  - ⇒ All values have been changed.
- ⇒  - Exit the screen to save the changes.

## Procedure

To change a selected value:

1.  - Open the ISOBUS-TC application.
2. Tap "Fields".
3. Tap on the field to be edited.
4. Tap .
5. In the column with the target rates (left), tap the value that you want to change.
  - ⇒ The keyboard appears.
6. Enter the new value.
7.  - Confirm.
  - ⇒ The "Prescription maps" screen appears.
  - ⇒ The new value appears in the cell you have changed.
8.  - Exit the screen to save the changes.

### 10.4.4

#### ISO-XML prescription maps

Prescription maps in ISO-XML format are created in an electronic Farm Management Information System and are transmitted to the terminal with an ISO-XML task.

The ISOBUS-TC license is required to edit them.

Working with ISO-XML tasks is described in the instructions for ISOBUS-TC.

### 10.5

#### MULTI-Control

After activating the MULTI-Control license, you can use the ISOBUS-TC app to assign multiple prescription maps to a machine.

This is necessary in two cases:

- MULTI-Rate - If the machine applies only one product that is metered by several metering units. For example, a field sprayer with two tanks and two control manifolds.
- MULTI-Product - If the machine has several tanks that are used to apply different products at different rates. For example: Planter/seeder with liquid fertilizer.

MULTI-Control is described in separate operating instructions.

**Work modes**

Function	Operating mode: Standard	Operating mode: Extended
MULTI-Product	not possible	possible
MULTI-Rate	possible	possible

## 11 FILE-Server application

The FILE-Server application is used to define a save location on the terminal. This save location can be used by all ISOBUS implements which do not have their own USB interface. This enables the updating of certain ISOBUS job computers, and also the possibility of saving, for example protocols or error messages.



A "Fileserver" folder is created for this purpose on the hard disk of the terminal. All ISOBUS implements can access this folder, and write or read data there.

The folder has a maximum disk space of 5 MB.

### Procedure

If you want to copy files to the terminal, these must be on your USB memory device, in the "Fileserver" folder.

The "FILE-Server" plug-in is activated.

1.  - Open the FILE-Server application.  
⇒ The application start screen appears.
2. Tap "Storage".
3.  - Copy files from the USB memory device onto the terminal (Import).
4.  - Copy files from the SD card in the terminal to the USB memory device (Export).  
⇒ One of the following messages appears: "Start import?" or "Start export?".
5. To confirm, tap "Yes".  
⇒ The data will be copied.  
⇒ Here is an overview of the folders on the USB memory device: Folders on the USB memory device [→ 30]  
⇒ A report appears.
6. To confirm, tap "OK".  
⇒ You have successfully imported or exported the data.

## 12 Technical specifications

### 12.1 Technical specifications of the terminal

Operating voltage	10 V – 32 V
Current consumption (operation)	1.3 A (typical) - 5 A
Power input	Typical: 15 W
	Maximum: 60 W
Ambient temperature	-30°C - +70°C
Storage temperature	-30°C - +85°C
Dimensions (W x H x D)	344.6 mm x 253.9 mm x 86.4 mm
Weight	3.8 kg
Protection class	IP6KX according to ISO 20653:2013
EMC	ISO 14982
ESD protection	ISO 10605:2001 Level IV
Environmental testing	Vibration: ISO 15003 Level 1 with Level 2 temperature overlap in accordance with ISO 15003  Shock: 100 shocks per axis and direction with 15g and 11ms in accordance with IEC 60068-2-27
Processor	i.MX 515 600 MHz
Coprocessor	STM32F105
Storage	256M mDDR
Bootflash	128M SCL-NAND-Flash
Operating system	WinCE 6.0
Display	12.1" XGA TFT
Housing	Aluminium
Inputs / outputs	1 x USB 1 x Sub-D 9 socket (CAN and power supply)

	<ul style="list-style-type: none"> <li>1 x Sub-D 9 connector</li> <li>1 x Sub-D 9 connector</li> <li>1 x M12 (D: Camera)</li> <li>1 x M12 (E: not used)</li> <li>1 x M12 (Industrial Ethernet)</li> <li>1 x SMA (GSM antenna)</li> </ul>
--	--

## 12.2

### Pin-out diagrams

#### 12.2.1

##### Port A (CAN bus)

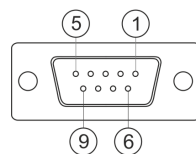

9-pin Sub-D socket

Pin	Signal name	Function
1	CAN_L	CAN_L out
6	-Vin	Supply ground
2	CAN_L	CAN_L in
7	CAN_H	CAN_H in
3	CAN_GND	CAN ground, internally connected to the ground
8	CAN_EN_out	Switched input voltage, $\leq 250$ mA
4	CAN_H	CAN_H out
9	+Vin	Supply
5	Ignition	Ignition signal
Electromagnetic shielding	Electromagnetic shielding	ESD/EMV shielding

#### 12.2.2

##### Port B

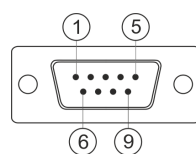

9-pin Sub-D connector

Port B is a 9-pin Sub-D connector.

The connector can be used for the following purposes depending on its assignment:

Purpose	Pins used
As second CAN interface	7, 9
As second serial interface	2, 3, 4, 5
As signal input for two digital and one analog signal.	1, 5, 6, 8

Pin	Signal name
1	Wheel sensor <sup>1</sup>
6	PTO <sup>2</sup>
2	/RxD2
7	CAN2_H
3	/TxD2
8	Work position sensor <sup>3</sup> or Reverse signal for determining the course
4	Voltage supply for GPS receiver Switched input voltage, ≤ 500 mA
9	CAN2_L
5	GND
Electromagnetic shielding	ESD/EMV shielding

Legend:

- 1) Digital input as per: ISO 11786:1995 chapter 5.2
- 2) Digital input as per: ISO 11786:1995 chapter 5.3
- 3) Analog input as per: ISO 11786:1995 chapter 5.5

### 12.2.3

#### Port C

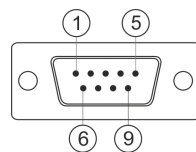

9-pin Sub-D connector

Pin	Signal name	Function
1	(DCD1)	Switched input voltage, ≤ max. 250 mA total (Pin 1



Pin	Signal name	Function
		+ Pin 4)
6	DSR	DSR
2	/RxD	/RxD
7	RTS	RTS
3	/TxD	/TxD
8	CTS	CTS
4	(DTR)	Switched input voltage, ≤ max. 250 mA total (Pin 1 + Pin 4)
9	(RI)	5 V ≤ 250 mA
5	GND	Signal ground
Electromagnetic shielding	Electromagnetic shielding	ESD/EMV shielding

## 12.2.4

### Ports D and E (camera)

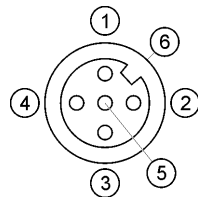

M12 socket: Camera

Pin	Signal name	Function
1	Power	Voltage supply, max. 500mA total
2	Power GND	Supply ground
3	FBAS2	Camera
4	FBAS	Camera
5	Signal GND	Signal ground
6	Electromagnetic shielding	ESD/EMV shielding

## 12.2.5

## ETH (Ethernet) port

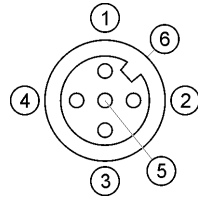

M12 socket: Ethernet

Pin	Signal name	Function
1	TD+	white-orange
2	RD+	white-green
3	TD-	orange
4	RD-	green
5	Pin not present	Pin not present
Electromagnetic shielding	Electromagnetic shielding	ESD/EMV shielding

## 12.3

## Licence conditions

The software uses the following open source libraries:

- Eigen  
<http://www.mueller-elektronik.de/LICENCES/eigen/LICENSE.txt>
- SpatiaLite  
<http://www.mueller-elektronik.de/LICENCES/spatialite/LICENSE.txt>
- Proj.4  
<http://www.mueller-elektronik.de/LICENCES/proj.4/LICENSE.txt>
- Expat  
<http://www.mueller-elektronik.de/LICENCES/expat/LICENSE.txt>
- WCELIBEX  
<http://www.mueller-elektronik.de/LICENCES/wcelibex/LICENSE.txt>
- Agg  
<http://www.mueller-elektronik.de/LICENCES/agg/LICENSE.txt>
- Poco C++  
<http://www.mueller-elektronik.de/LICENCES/poco/LICENSE.txt>
- QT  
<http://www.mueller-elektronik.de/LICENCES/qt/LICENSE.txt>
- Boost  
<http://www.mueller-elektronik.de/LICENCES/boost/LICENSE.txt>

## 13 Troubleshooting

The following error messages can appear during operation, amongst others:

### General

Error message text	Possible cause	Possible error correction
Some files could not be deleted.	The files that should be deleted are currently being used.	
Object pool error		Delete the object pool and restart the terminal. [→ 55]
ECU: Offline - The connection has been broken.	The connections between the terminal and ECU have been broken.	Check the connection. [→ 17]

### GPS

Error message text	Possible cause	Possible error correction
GPS receiver reset failed.	The wrong driver was selected.	Select the correct driver. [→ 32]
	The external lightbar is activated.	Deactivate the external lightbar [→ 44] and connect the GPS receiver directly to the terminal. [→ 32]
The GPS receiver is not enabled for E-Dif.	There is no E-Dif activation on the GPS receiver.	Please contact technical support.
GPS receiver has been removed.	The connection between the terminal and GPS receiver has been broken.	Check the connection. [→ 32]
	The GPS receiver has been configured for TRACK-Leader AUTO.	Reset the baud rate for the GPS receiver. [→ 34]
GPS receiver not initialized.	The terminal does not recognise the configuration of the GPS receiver.	Reset the GPS receiver to its factory settings. [→ 34]
Timeout.	The wrong driver was selected.	Select the correct driver. [→ 32]
	The external lightbar is activated.	Deactivate the external lightbar [→ 44] and connect the GPS receiver directly to the terminal. [→ 32]
SIM card is not unlocked.	The PIN request for the SIM card is activated.	Deactivate the PIN request for the SIM card.
Invalid entry.	Unauthorised special characters were used in the entry.	Correct the entry.
The connected receiver could not be recognized.	The wrong driver was selected.	Select the correct driver. [→ 32]
	An unknown GPS receiver has been connected.	Use the default GPS driver. [→ 32]

Error message text	Possible cause	Possible error correction
The modem is not answering.	The connection between the GPS receiver and GSM modem has been broken.	Check the connection.
	The modem is not ready for communication yet.	Please wait for a moment.
		Restart the system.
The driver cannot read.	The external lightbar is activated.	Deactivate the external lightbar [→ 44] and connect the GPS receiver directly to the terminal. [→ 32]
The driver cannot write.		

### Tractor-ECU

Error message text	Possible cause	Possible error correction
A vehicle must be activated!	There is currently no activated vehicle.	Activate a vehicle. [→ 58]
Active tractor geometry may be incomplete. Check settings.		Check the tractor geometry. [→ 63]

### Virtual ECU

Error message text	Possible cause	Possible error correction
Caution! The geometry settings for the machine have been reset.	The geometry of the virtual ECU is faulty.	Check the geometry of the virtual ECU. [→ 70]
The connection to the external controller has been interrupted.	The connection between the terminal and the external on-board integrated display/controller has been broken.	Check the connection. [→ 45]
Error! There is no active machine.	There is currently no activated machine.	Activate a machine. [→ 68]
This profile name already exists! Abort entry?	The identical profile name has already been used.	Enter a different profile name. [→ 69]
Working width or sections have not been entered or are invalid. Abort entry?	The entries for the working width and sections are incomplete.	Check the settings for the working width and the sections. [→ 70]



